

*Procedia*  
***Environmental  
Science,  
Engineering and  
Management***

21st International Trade Fair of Material & Energy  
Recovery and Sustainable Development,  
ECOMONDO,  
7th-10th November, 2017, Rimini, Italy

Selected papers (3)



***P - ESEM***

---

*Procedia*  
**Environmental Science,  
Engineering and Management**

---

<http://www.procedia-esem.eu>

**Volume 4, Issue 3, 2017**

***Procedia***  
**Environmental  
Science,  
Engineering and  
Management**

**Editor-in-Chief: Maria Gavrilescu**  
**Co-editor: Alexandru Ozunu**  
**Guest Editors: Fabio Fava & Grazia Totaro**

**21th International Trade Fair of Material & Energy Recovery and  
Sustainable Development, ECOMONDO,  
7th-10th November, 2017, Rimini, Italy**

**Selected papers (3)**

---



## Aims and Scope

*Procedia Environmental Science, Engineering and Management (P - ESEM)* is a journal focusing on publishing papers selected from high quality conference proceedings, with emphasis on relevant topics associated to environmental science and engineering, as well as to specific management issues in the area of environmental protection and monitoring.

*P - ESEM* facilitates rapid dissemination of knowledge in the interdisciplinary area of environmental science, engineering and management, so conference delegates can publish their papers in a dedicated issue. This journal will cover a wide range of related topics, such as: environmental chemistry; environmental biology; ecology geoscience; environmental physics; treatment processes of drinking water and wastewater; contaminant transport and environmental modeling; remediation technologies and biotechnologies; environmental evaluations, law and management; human health and ecological risk assessment; environmental sampling; pollution prevention; pollution control and monitoring etc.

We aim to carry important efforts based on an integrated approach in publishing papers with strong messages addressed to a broad international audience that advance our understanding of environmental principles. For readers, the journal reports generic, topical and innovative experimental and theoretical research on all environmental problems. The papers accepted for publication in *P – ESEM* are grouped on thematic areas, according to conference topics, and are required to meet certain criteria, in terms of originality and adequacy with journal subject and scope.



**Editorial Board:**

**Editor-in-Chief:** **Maria Gavrilesu**, *Gheorghe Asachi* Technical University of Iasi, Romania

**Co-Editor:** **Alexandru Ozunu**, *Babes-Bolyai* University Cluj-Napoca, Romania

**Scientific Advisory Board:**

**Maria Madalena dos Santos Alves**  
University of Minho, Braga  
Portugal

**Andrea Critto**  
University Ca'Foscari, Venice  
Italy

**Nicolas Kalogerakis**  
Technical University of Crete, Chania  
Greece

**Abdeltif Amrane**  
University of Rennes, ENSCR  
France

**Katerina Demnerova**  
University of Prague  
Czech Republic

**Gabriel Lazar**  
University *Vasile Alecsandri* Bacau  
Romania

**Adisa Azapagic**  
The University of Manchester  
United Kingdom

**Fabio Fava**  
*Alma Mater Studiorum* University of  
Bologna, Italy

**Antonio Marzocchella**  
University of Naples *Federico II*,  
Naples, Italy

**Calin Laurentiu Baciu**  
*Babes-Bolyai* University Cluj-Napoca  
Romania

**Anton Friedl**  
Vienna University of Technology  
Austria

**Akos Redey**  
Pannon University, Veszprem  
Hungary

**Hans Bressers**  
University of Twente,  
The Netherlands

**Eugenio Campos Ferreira**  
University of Minho, Braga,  
Portugal

**Geta Risnoveanu**  
University of Bucharest  
Romania

**Anca Duta**  
*Transilvania* University of Brasov  
Romania

**Ion Giurma**  
*Gheorghe Asachi* Technical  
University of Iasi,  
Romania

**Brindusa Mihaela Robu**  
*Gheorghe Asachi* Technical  
University of Iasi,  
Romania

**Dan Cascaval**  
*Gheorghe Asachi* Technical  
University of Iasi,  
Romania

**Alexandra Raluca Iordan**  
*Al.I. Cuza* University of Iasi,  
Romania

**Carmen Teodosiu**  
*Gheorghe Asachi* Technical  
University of Iasi,  
Romania

**Yusuf Chisti**  
Massey University, Palmerston North  
New Zealand

**Ralf Isenmann**  
Munich University of Applied  
Sciences  
Germany

**Vincenzo Torretta**  
Universita degli Study dell'Insubria,  
Varese  
Italy

**Philippe Xavier Corvini**  
University of Applied Sciences  
Northwestern Switzerland, Muttenz,  
Switzerland

**Andries Jordaan**  
University of Free State,  
Bloemfontein  
South Africa

**Grigore Vlad**  
*Institute for Research and Design in  
Electronics*  
*Bistrita, Romania*

**Igor Cretescu**  
*Gheorghe Asachi* Technical  
University of Iasi,  
Romania

**Michael Søgaard Jørgensen**  
Aalborg University  
Denmark

**Stefanos Xenarios**  
Norwegian Institute for Agricultural  
and Environmental Research  
(Bioforsk), Oslo, Norway





## GUEST EDITORS



**Fabio Fava**, born in 1963, is Full Professor of "Industrial & Environmental Biotechnology" at the School of Engineering of University of Bologna since 2005. He has about 130 papers on medium/high IF peer-reviewed international journals of industrial and environmental biotechnology, sectors in which he coordinated the FP7 projects NAMASTE and BIOCLEAN and participated in other 7 FP7 collaborative projects. He is vice-chairman of the "Environmental Biotechnology" section of the European Federation of Biotechnology (EFB). He is the Representative of the Italian Ministry of Education, University and Research in the "Working Party on Biotechnology, Nanotechnology and Converging Technologies" at OECD (Organisation for Economic Co-operation and Development), Paris, in the "European Strategy for the Adriatic and Ionian Region" (EUSAIR) and in the "Western Mediterranean Initiative" (WEST MED). He is member of the "Expert Group on Biobased Products" (DG GROW, European Commission, EC) and is the Italian Representative in the a) H2020 Programming Committee "European Bioeconomy Challenges: Food Security, Sustainable Agriculture and Forestry, Marine, Maritime and Inland Water Research" (SC2, DG RTD, EC), b) "States Representatives Group" of the "Public Private Partnership BioBased Industry" (BBI JU)(DG RTD, EC) and c) BLUMED Strategic Board (DG RTD and DG MARE, EC). Finally, he is the scientific coordinator of the International Exhibition on green and circular economy ECOMONDO held yearly in Rimini (Italy).



**Grazia Totaro**, born in 1976, has a degree in Chemistry (University of Ferrara), a Master's Degree in Science, Technology & Management with a specialization in Environmental Chemistry (University of Ferrara) and a PhD in Materials Engineering (University of Bologna). She worked at the R&D Centre of Basell Polyolefins in Ferrara for 2 years in the frame of a project addressed to the development of a novel methodology for qualitative and quantitative analysis of additives in polymers. She also worked at ARPA, Regional Agency for Environment in Ferrara, division Water Analysis. Then she started working at the school of Engineering of the University of Bologna for a Ph.D. in Materials Engineering (2007-2010). After that, she had a scholarship "Spinner 2013" in cooperation with Reagens spa (San Giorgio di Piano) on novel PVC nanocomposites. Now she is post doc fellow at the same school on new polymer-based nanocomposites from renewable sources and inorganic fillers. She also worked at the laboratoire de Chimie et Biochimie Pharmacologique et Toxicologique (Université René Descartes) in Paris in 2001 and was visiting professor at the Ecole Nationale Supérieure de Chimie (Université Blaise Pascal, Clermont Ferrand, FR) in 2012 and 2015. Dr. Totaro has about 25 scientific papers and several participations at conferences and scientific schools. She collaborates on Ecomondo from 2013.

[\(http://en.ecomondo.com/\)](http://en.ecomondo.com/)

Procedia Environmental Science, Engineering and Management 4 (2017) (3) 135-206

21th International Trade Fair of Material & Energy Recovery and Sustainable Development,  
 ECOMONDO, 7th-10th November, 2017, Rimini, Italy

---

## CONTENTS

**THE BIOECONOMY IN SICILY: NEW GREEN MARKETING STRATEGIES APPLIED TO THE SUSTAINABLE TOURISM SECTOR**

Elisa Maugeri, Enrica Gullo, Paola Romano, Federica Spedalieri,  
 Alfio Licciardello..... 135

**EFFECTIVE SOLID WASTE MANAGEMENT IN THE CIRCULAR ECONOMY: THE CASE STUDY OF LAGOS STATE, NIGERIA**

Olukemi Oyelola, Isaac Ajiboshin, John Okewole ..... 143

**ENVIRONMENTAL PRODUCT DECLARATION AS A STRATEGY TO APPLY BIO ECONOMY IN THE SUSTAINABLE STEEL SECTOR**

Marco Palmieri, Federica Ragaglia, Sebastiano Patanè, Paolo Piana,  
 Carlo Ingraio, Alberto Bertino ..... 149

**HYDROGEN PRODUCTION FROM FOOD WASTE USING BIOCHEMICAL HYDROGEN POTENTIAL TEST**

Isabella Pecorini, Francesco Baldi, Elena Albini, Giovanni Galoppi,  
 Donata Bacchi, Andrea Della Valle, Andrea Baldi, Alessandro Bianchini,  
 Alfonso Figini, Patrizia Rossi, Paola Paoli, Carlo Carcasci, Giovanni Ferrara,  
 Ennio Antonio Carnevale..... 155

**OPTIMIZATION OF HYDROGEN AND METHANE PRODUCTION IN TWO-PHASE ANAEROBIC DIGESTION**

Isabella Pecorini, Giovanni Ferrara, Giovanni Galoppi, Francesco Baldi,  
 Donata Bacchi, Elena Albini, Caterina Susini, Alessia Scappini,  
 Lidia Lombardi ..... 163

<b>BIOFILTRATION PROTOTYES FOR METHANE OXIDATION  IN LANDFILL AFTERCARE AND ABATEMENT  OF NMVOCs AND ODOROUS COMPOUNDS</b> Isabella Pecorini, Donata Bacchi, Giovanni Ferrara1, Elena Rossi, Renata Laura Caselli, Luca Zipoli, Fabio Menghetti .....	<b>173</b>
<b>COST AND BENEFIT ANALYSIS AS A TOOL TO SUPPORT  DECISIONS ON ENERGETIC STREAMLINING  IN THE GREEN BUILDING SECTOR</b> Martina Sgandurra, Giulia Salerno, Alessia Passalacqua, Cinzia Martelli, Antonella Rinaldo .....	<b>183</b>
<b>MASS BALANCE AS ECONOMIC AND SUSTAINABLE STRATEGY  IN WEEE SECTOR</b> Giovanna Tuccio, Pietro Bua, Giuseppe Teodoro, Francesco Failla, Vincenzo Antonio Giuffrida .....	<b>191</b>
<b>CARBON DIOXIDE BALANCE OF WOODEN STRUCTURES:  CIRCULAR ECONOMY IN THE ECOLOGICAL  BUILDING INDUSTRY</b> Domenico Licciardello, Sefora Leah Spatafora, Ludovica Vizzini, Cinzia Martelli, Claudio Francesco Vincenzo Martelli .....	<b>199</b>



Procedia Environmental Science, Engineering and Management, 4 (2017) (3) 135-142

21th International Trade Fair of Material & Energy Recovery and Sustainable Development,  
ECOMONDO, 7th-10th November, 2017, Rimini, Italy

---

## **THE BIOECONOMY IN SICILY: NEW GREEN MARKETING STRATEGIES APPLIED TO THE SUSTAINABLE TOURISM SECTOR\***

**Elisa Maugeri<sup>1\*\*</sup>, Enrica Gullo<sup>1</sup>, Paola Romano<sup>1</sup>,  
Federica Spedalieri<sup>1</sup>, Alfio Licciardello<sup>2</sup>**

<sup>1</sup>*Department Economics and Business, University of Catania Corso Italia 55, 95129- Catania*

<sup>2</sup>*Hotel Primavera dell'Etna Via Cassone, 86, 95019 Zafferana Etnea CT*

---

### **Abstract**

The bioeconomy is a new economic strategy that underlines environmental opportunities, through the concepts of the circular economy or thanks to some tools such as LCA. The aim of this paper is to analyze the environmental impact of the tourism industry through the LCA analysis. Lately, the tourism sector has grown and offers different services such as transport, hospitality and entertainment. The LCA (Life Cycle Assessment), internationally standardized by the ISO 14040 and 14044 standards, is a technique that studies the environmental effects of all the stages of a service considering changes in the ecosystem, consumption of natural resources and the damage to human health. The functional unit of this study is a "Trip and overnight stay in a hotel during mid-season with the arrival and departure of the tourist at Fontanarossa Airport in Catania, Sicily". The tourist arrives at Fontanarossa Airport and must take transport to get to the Hotel Primavera dell'Etna, Zafferana; the transport used involves the emission of CO<sub>2</sub> and other substances which cause air pollution. The overnight stay in a hotel implies multiple environmental consequences caused by the consumption of specific items such as light bulbs, television, disposable products, air conditioning and electricity in general. The tourist's hotel stay is half board including dinner and breakfast. After breakfast, the tourist will return to Fontanarossa Airport taking private or public transport. The tourism sector is important for the development of a country's economy. There is a strong relationship between the two elements of tourism and the environment because, on the one hand, for tourism, the environment is a fundamental resource but, on the other hand, it must be deeply analyzed because an uncontrolled spread of tourism could cause serious environmental damage. The LCA makes it possible to split the entire tourism industry into different steps focusing, not only on the evaluation of the total impact, but especially on the analysis of all the effects created in each phase.

*Key words:* bioeconomy, ecotourism, environmental impacts, green marketing, LCA

---

\*Selection and peer-review under responsibility of the ECOMONDO

\*\*Corresponding author: e-mail: [elisa.maugeri@tiscali.it](mailto:elisa.maugeri@tiscali.it)



## 1. Introduction

A circular economy is a continuous positive development cycle that preserves and enhances natural capital, optimizes resource yields, and minimizes system risks by managing finite stocks and renewable flows. It works effectively at every scale. (<https://www.ellenmacarthurfoundation.org>)

Tourism represents one of the driving sectors of the economy on a global scale and it's necessary for its importance to observe and analyze its environmental impact. Negative impacts occur because tourism, both international and domestic, causes an intermingling of people from diverse social and cultural backgrounds, and also a considerable spatial redistribution of spending power, which has a significant impact on the economy of the destination. Tourism consequences cannot be preventing, but need to be planed and managed to minimize the negative impacts and accentuated the positive impacts of tourism.

The definition of ecotourism was coined in 2002 at the World summit of ecotourism in Quebec (Canada), and delegates of 132 countries approved the Quebec declaration of ecotourism. (<http://www.ecoage.it>)

Ecotourism is now defined as the following: "responsible travel to natural areas that conserves the environment, sustains the well-being of the local people, and involves interpretation and education" (TIES, 2015). Definitions focus on 'environmentally responsible' tourism that provides 'direct benefits' to the nature conservation area and to 'the economic welfare of local residents', or a nature tourism that promotes conservation and sustainable development' (Wunder, 1999). A community-based approach to ecotourism recognizes the need to promote both the quality of life of people *and* the conservation of resources. Even where ecotourism results in economic benefits for a local community, it may result in damage to social and cultural systems thus undermining people overall quality of life (Scheyvens, 1999). At the same time, the respect towards tourism refers to both citizens and tourists because ecotourism is based on respect for values by tourists themselves, without which there is no reason to exist. But it is also a rational behavior of the same local populations that sustainably manage their natural and cultural heritage, which ensures long-term economic activity in the long run.

The evaluation of the activities performed using both methods could provide more extensive and comprehensive results and could lead to a more reliable evaluation of the system providing better support for decision making (Castellani and Sala, 2012). Sustainable tourism has a direct connection with the Life Cycle Assessment method. The LCA is the evaluation of the environmental impact related to the entire vacation. This can include but not limit the following aspects: trip, transport, overnight stay etc.

Tourist services can be interpreted as a series of consequential processes which, when viewed together, trace the life cycle of the tourist service. Since tourism is a composite product, when the tourists begin their trip, the life cycle of the "tourism product" starts; and when tourists finish their trip, the life cycle of the "tourism product" ends. Accordingly, every sector of the whole trip including transportation, accommodation, and recreation is all considered and the environmental impacts of the whole trip can be inventoried under such approach (Kuo and Chen, 2009).

The general process can be schematized through a stream of activities that characterize the distinct phases which are common to the different forms of tourism. This process, from a life cycle perspective for its implementation, requires that inputs are taken from environment and territory. Taking into account the wide panorama of the companies in the tourist sector, the LCA method applied to this sector can be used as a lever of green marketing. This, in turn, allows the company to distinguish itself from its competitors thanks to the possibility of obtaining an eco-label. The Eco label represents an element of prestige in the eyes of tourists increasingly sensitive to these issues.

The aim of this paper is to analyze how back up instruments for tourism, in this case the LCA, can become strategies of the application of the circular economy. The firm that has been studied is a hotel facility in the territory of Catania with a lifelong experience in the sector. The main advantage of this research in the field of international literature about the sector is to underline the social benefits exploitable from an economic perspective. Through the LCA tool, it is possible to highlight the inefficiencies of the various phases and to improve them from the environmental point of view by reducing consumption and emissions besides other positive economic consequences.

## **2. Methods**

LCA is a technique to assess the environmental aspects and potential impacts associated with a product, process, or service, by:

- compiling an inventory of relevant energy and material inputs and environmental releases;
- evaluating the potential environmental impacts associated with identified inputs and emissions;
- interpreting the results to help make a more informed decision about the human health and environmental impacts of products, processes, and activities.

For a typical product, LCA takes into account the supply of raw materials needed to produce the product, the manufacturing of intermediates and finally the product itself, including packaging, transportation and the disposal of the product after it has been used. This sequence, as depicted below, is called “Cradle to Grave” assessment.

There are four main phases of the LCA process (B Corporation, 2008):

### *“1. Goals and Scoping*

The scoping step determines which processes will be included, which environmental concerns will be taken into account, what economic or social good is provided by the goods or services in question, it resolves any technical issues and defines the audience for the LCA.

### *2. Life Cycle Inventory (LCI)*

The inventory provides information about all environmental inputs and outputs from all parts of the product system involved in the life cycle assessment. This involves modeling of the product system, data collection and verification of data for inputs and outputs for all parts of the product system.

Inputs include: materials, energy, chemicals and ‘other’.

Outputs include: air emissions, water emissions and solid waste.

### *3. Life Cycle Impact Assessment*

The assessment takes inventory data and converts it to indicators for each impact category. A typical list of impact indicators includes:

- Global Climate Change
- Stratospheric Ozone Depletion
- Smog
- Acidification
- Eutrophication
- Natural Resources (habitat, water, fossil fuels, minerals, biological resources)
- Human Toxicity
- Ecotoxicity

### *4. Interpretation*

The last step is an analysis of the impact data, which leads to the conclusion whether the ambitions from the goal and scope can be met” (B Corporation, 2008).

The LCA methodology has continued to develop and has become to some extent mature during recent decades. From the first conceptualizations, LCA is now an

internationally standardized methodology (ISO 14040, 2006; ISO 14044, 2006) recognized by the European Commission (2003) as the best tool for assessing the life cycle environmental impacts of products. While general guidelines for LCA have been issued by the European Commission (2010), many initiatives have been developing *ad hoc* sector- and product-specific methodologies. According to a preliminary survey on the use of LCA in the tourism industry, LCA is still uncommon within the tourism industry and for researchers in the field of Sustainable Tourism.

According to Judd (2006), the actual product of tourism is the tourist's experience which is generated by several social and economic actors. Middleton (1989) observed that the term "tourist product" is used at two different levels: the "specific" level (i.e. a discrete product offered by a single business, such as a sightseeing tour or an airline seat) and the "total" level (i.e. the complete experience of a tourist from the time one leaves home to the time one returns). From these considerations, it can be deduced that a tourist's experience is the outcome of a tourist product at a "total" level. Such a product can be seen as a system whose components (products and services) are the tourist products at a "specific" level, which are provided by different actors and may be incidental to "non-economic" activities.

Tourism is a complicated system due to the large number of goods and supporting services involved in it. Furthermore, describing the sector is complicated as, scientifically, there is an on-going debate about the definition of tourism. Therefore, applying LCA to calculate the environmental performance of tourist products is often problematic. In particular, these drawbacks have major implications in the "goal and scope definition" step (De Camillis et al., 2012)

### 3. Experimental

The study of the LCA of a service or product analyzes each phases from "cradle to grave", in order to establish which are the steps and moments in which the environmental concerns develop. In this paper, the LCA analysis is applied to the Hotel Primavera dell 'Etna. This Hotel is in Zafferana Etnea, Catania, Sicily in a tourist road Mareneve Sud located between the Mediterranean Sea and Mount Etna.

The facility was renovated in 2002 with the aim to improve the costumer comfort and satisfaction and to reduce the energy consumption and its environmental impacts.

The LCA analysis is based on four distinct phases:

1. Identification of the functional unit;
2. Life Cycle Inventory - LCI;
3. Life Cycle Impact Assessment;
4. Lyfe Cycle Interpretation

The functional unit taken into consideration is a "Trip and overnight stay in a hotel during mid- season with the arrival and departure of the tourist at Fontanarossa Airport in Catania, Sicily".

The ambit of the study goes from the transfer of the client from the airport to the check out in the hotel, which means: transfer from the Fontanarossa airport to the Hotel Primavera dell 'Etna, overnight stay, dinner, breakfast, check out.

The consumption analyzed in this study are (Deng and Burnett, 2000; Gossling, 2002):

- Consumption of fuel (gasoline) needed for the transfer by car from the airport to the Hotel;
- Consumption of the overnight stay: water, sheets, towel, courtesy kit, breakfast and the energy's consumption associated to the services used by the client such as television, bar service, hairdryer and toilette.

- Consumption related to the check out: Dishwashing utensils, bedroom cleaning and laundry service.

The inventory analysis of the life cycle is the main phase of the study and it is represented by quantitative data of all the material and energy flow at the beginning and at the end of the entire process. The output of the inventory analysis results in the filling out of a table which shows the use of the resources, the emission associated with the functional unit such as energy flow, air, water and waste. The input and output data was provided directly by the Hotel. Phases 3 and 4 allow the principal data to be elaborated and analysed in order to reach the final conclusion.

#### **4. Results and discussion**

The first phase considered is the transfer to the hotel which is located 38.6km from the airport. The main input of this phase is gasoline, oil and tire. The average of the gasoline used is 2.72 liters which generate an emission of 7295g of CO<sub>2</sub>, oil and tires are used for 0.13% generating respectively emission of NH<sub>3</sub> and the attrition of the tire.

The second phase analyzed, concerns the overnight stay of the customer in the Hotel; the relevant data are:

1. *Consumption of 0.528 m<sup>2</sup> of methane gas which generate emission of CO<sub>2</sub>;*
2. *Consumption of energy of the bedroom for a overnight stay of 14 hours per a total of 1.42 KW divided into:*
  - Hairdryer 0.08 kW
  - Television 0.51 kW
  - Minibar 0.40 kW
  - Lighting 0.40 KW
  - CPU 0.028 kW
3. *Consumption related to the toilet*
  - Water: 150 l
  - Shampoo: 20 g
  - Bubble bath: 50g
  - Soap: 13 g
4. *Consumption related to breakfast:*
  - Water bottle: 0.5l
  - Coffee: 7 g
  - Cracked slice: 17g
  - jam :25 g
  - Butter: 8g
  - sugar: 5g
  - napkin: 2 pieces

The energy consumption of this Hotel is considerably lower than other hotel facilities, which do not operate in a green economy, thanks to the investment made by the company. In 2002 the heating system VRV-CLIMATIZZATOR MULTIZONA was installed. The system is equipped with centralized control so every room and floor of the whole hotel has heating, cooling and ventilation necessary without the need to waste energy to air-conditioning non-temporarily inhabited areas (Deng and Burnett, 2000). In addition, these systems operate with intelligent energy management by optimizing seasonal performance. In addition, in 2014, a 63 kwp photovoltaic plant was installed on the roof of the building, meeting the needs of 21 private rooms, exploiting for solar power generation, clean and renewable energy as well as reducing energy costs. Connected with the photovoltaic system and with the

concept of energy saving, a process of energetic qualification of the structure has started, beginning with energy efficiency, thanks to the replacement of energy-saving lamps with LED technology lamps. In the last phase, check out, all the waste generated during the check-in and stay phase is analyzed. Waste generated for the sanitary facilities include: pvc bottles for the use of shampoo and bubble bath and paper packaging for the use of soap.

The waste generated for breakfast is: glass bottle, PVC pack for cookies, jam jar, butter wrapping, sugar paper bag and paper napkins. Speaking of waste management, with a view to carrying out its activities with the least environmental impact and also following the initiatives of the municipality of Zafferana Etnea, the management is committed to reducing waste incineration as much as possible, reducing the amount of undifferentiated donation, and carrying out a very accurate differentiated collection. In this way, at present, the hotel can differentiate between 80% and 85% of its waste.

The application of the LCA in the Hotel Primavera dell'Etna showed that the main emissions caused by Italian tourism, tourism in southern Italy, is the CO<sub>2</sub> emissions caused mainly by the use of private means of transport. The paper showed, however, that the amount of energy used by the structure (1.42 KW) for one night, is relatively low compared to other tourist facilities. As a matter of fact, that amount is less than that consumed by other hotels in different nations; for example, the average of energy consumption in a hotel room in Hong Kong is: 32% of total energy were consumed for air conditioning, 12% for lighting, 5% for lifts and escalators, 23% for other systems/appliances, and 28% for cooking and water heating (the latter based on gas and diesel).

A study (electricity only) of hotels in Hong Kong indicated a very high average electricity consumption of 10.9 MJ per bed night. However, this may underestimate total energy consumption by one-quarter, and such low values will generally only be the case in city hotels. Hotels investigated in the Seychelles indicated an energy use of 36–108 MJ per bed night, excluding the use of fossil fuels for cooking etc. Hotels with self-supporting power generation may even use more energy per bed night. Finally, the amount of energy consumed is low compared to other hotels in southern Italy thanks to the investments made by the hotel, or through the installation of the VRV-CLIMATIZZATOR MULTIZONA system.

LCA highlights strengths and weaknesses, from a point of view of the effects on the environment, of the chains, identifying the phases that have a greater environmental impact. The advantage of this analysis is that it allows for each of the environmental impact factors (emissions, waste, discharges, etc.) to specify its origin by attributing it percentage to the distinct stages of the life cycle. The inventory analysis makes it possible to highlight the energy resources and products needed for the training process of the offered service, quantifying the resources needed during the consecutive lifecycle impact assessment phase. LCI is a very detailed, simple compilation tool but it is quite difficult to find individual data, very schematic and capable of quantifying the data sought. In the case of the tourist service examined, the choice of functional unit was crucial in identifying the environmental impacts attributed to a single tourist because it made it possible to locate exactly where it is possible to intervene to make tourism more sustainable.

Improvement proposals based on inventory results or impact assessment can help decision-makers identify and evaluate ways to reduce impacts on the environment of products or services. Since LCA studies are long, expensive and complex (as it is necessary to acquire a large amount of environmental data during each stage of the production process), more and more "simplified LCA" tools are being developed. They enable a quick review of the life cycle and environmental performance of products, even to those which do not have all the skills and resources needed to carry out a detailed study.

## 5. Conclusions

The LCA methodology applied in the Hotel Primavera dell'Etna revealed that the main emissions caused by tourism in southern Italy is represented by the CO<sub>2</sub> emissions, produced largely by the use of private transport resources. However, the amount of energy used by the structure (1.42 KW) for one night is relatively low, related to other tourist facilities. That amount is less than that consumed by other hotels in different nations.

Given the importance of reliable data availability for the success of an LCA study on an international and European level, it is important to promote accessibility, availability and free exchange and Small and Medium Businesses Free LCA data through the development of Public Data Banks, protected, compatible, transparent and accredited.

The main advantages can be summarized as follows:

- Significant economic savings characterized by an initial investment but savings in the medium term.
- Competitive advantage as they show a reduced environmental impact
- Identification of environmental issues during the life cycle of products or processes.
- Information and training for consumers and stakeholders.
- As a tool for certification of corporate environmental management systems (SGAs) for both ISO 14000 and EMAS Community Regulations. The LCA methodology allows the integration of the environmental variable with the core business functions in order to develop environmental management policies. This also helps to improve relations with institutions.
- Definition of eco-compatible strategies for urban solid waste management (RSU). The LCA methodology makes it possible to compare environmental loads with different alternatives by facilitating the choice of the disposal method that minimizes cost and environmental impact.

Therefore, despite the criticalities that can be found in the application of the LDA both from a technical (data acquisition) and economic (initial investment) point of view, the implementation of LCA is a useful tool and competitive for companies that apply it.

## References

- B Corporation, (2008), B Resource Guide: Conducting a Life Cycle Assessment (LCA), On line at: <https://www.scribd.com/document/169242913/B-Resources-Conducting-a-Life-Cycle-Assessment-LCA>.
- Castellani V., Sala S., (2012), Ecological Footprint and Life Cycle Assessment in the sustainability assessment of tourism activity, *Ecological Indicator*, **16**, 135-147.
- De Camillis C., Peeters P., Petti L., Raggi A., (2012), *Tourism Life Cycle Assessment (LCA): Proposal of a New Methodological Framework for Sustainable Consumption and Production*, In: *Visions for Global Tourism Industry - Creating and Sustaining Competitive Strategies*, Kasimoglu M. (Ed.), InTech, Rijeka, Croatia, 247-268.
- Gossling S., (2002), Global environmental consequences of tourism, *Global Environmental Change*, **12**, 283-302.
- ISO 14040, (2006), Environmental Management- Life Cycle Assessment-Principles and framework, On line at: <https://www.iso.org/standard/37456.html>
- ISO 14044, (2006), Environmental Management- Life Cycle Assessment-Requirements and guidelines, On line at: <https://www.iso.org/standard/38498.html>.
- Judd D.R., (2006), Commentary: Tracing the commodity chain of global tourism, *Tourism Geographies*, **8**, 323-336.
- Kuo N., Chen P., (2009), Quantifying energy use, carbon dioxide emission, and other environmental loads from island tourism based on a life cycle assessment approach, *Journal of Cleaner Production*, **17**, 1324-1330.
- Middleton V.C.T., (1989), *Tourism Product*, In: *Tourism Marketing and Management Handbook*, Witt S.F., Moutinho L. (Eds.), Prentice-Hall, Hempel Hempstead, 573-576.
- Scheyvens R., (1999), Ecotourism and the empowerment of local communities, *Tourism Management*, **20**, 245-249.



TIES, (2015), Ecotourism, The International Ecotourism Society (TIES), On line at: <https://www.parrots.org/ecotourism/the-international-ecotourism-society-ties>.  
Wunder S., (1999), Ecotourism and economic incentives- an empirical approach, *Ecological Economics*, **32**, 465–479.

**Web sites:**

<https://www.ellenmacarthurfoundation.org/circular-economy/overview/concept>  
<http://www.ecoage.it/ecoturismo.htm>

Procedia Environmental Science, Engineering and Management 4 (2017) (3) 143-148

21th International Trade Fair of Material & Energy Recovery and Sustainable Development,  
ECOMONDO,  
7th-10th November, 2017, Rimini, Italy

---

## **EFFECTIVE SOLID WASTE MANAGEMENT IN THE CIRCULAR ECONOMY: THE CASE STUDY OF LAGOS STATE, NIGERIA \***

**Olukemi Oyelola<sup>1\*\*</sup>, Isaac Ajiboshin<sup>2</sup>, John Okewole<sup>3</sup>**

<sup>1</sup>*Chemical Science Department, Yaba College of Technology, Lagos Nigeria*

<sup>2</sup>*Chemical Engineering Department, Yaba College of Technology, Lagos Nigeria*

<sup>3</sup>*UNEVOC Centre, Yaba College of Technology, Lagos Nigeria*

---

### **Abstract**

As urbanization intensifies and population increases in any country, consumption pattern of a range of resources changes. Applying the principle of sustainable development in Lagos State involves a new approach to solid waste using appropriate concept of circular economy taking into account the existing waste-to-wealth initiatives and zero waste objectives. The paper focuses on disposal which discourages waste generation and the role of government and other stake holders for the efficiency of waste management that supports the circular vision. A pilot study was carried out on the rate of generation, collection and composition of waste in four Local Government Areas of the State for a period of 24 months. The result showed that foods and packages wastes account for over 68% of what households throw away daily which constitutes a menace in the landfill, while a minute percentage collected is recovered in some forms mostly by the informal sector. The government and stake holders should ensure no food waste gets to landfill but employ different recycling methods according to individual waste streams.

*Keywords:* waste collection, waste generation, waste management

---

### **1. Introduction**

Lagos is an international megacity in Nigeria with an ever-growing population and wide spread environmental impact. It is a major financial Center in Africa. Its economic growth and pace of urbanization is continually changing the pattern of a range of resources. Significant quantities of solid waste are produced which generation, collection and management threatens the prosperity and sustainable development of the city.

---

\*Selection and peer-review under responsibility of the ECOMONDO

\*\* Correspondence author: [kemsol56@yahoo.com](mailto:kemsol56@yahoo.com)

Lagos State Waste Management Authority (LAWMA) was mandated to collect and transport commercial and industrial waste to designated landfill sites as well as manages the landfills. In 1997, Private Sector Participation (PSP) scheme was introduced to complement the efforts of LAWMA. The participants were assigned the responsibility of door to door / bulk waste collection in all the Local Government Areas at fees to be paid by serviced clients. For better performance, mega waste management companies were integrated to collect waste from tenements, markets, parks, industries and commercial centers within their zones for disposal at designated landfill sites. Cart pushers were equally integrated into the program in an effort to cope with the enormity of the waste (Akinmuleya, 2006). The collection Agents in Lagos State are: Lagos State Waste Management Authority (LAWMA), Private Sector Participants (PSP), Highway Managers Limited (HWM) and Local Governments (L/GOVT). There are four types of solid waste collection systems in operation in Lagos State. These are: Door to door collection, Bin collection, Communal / bulk collection and Street collection (Figs. 1-3). Different scholars noticed that there has been no time in the past twenty years when the Waste Management Agencies in Lagos catered for more than 70% -90% of the waste generated (Akoni, 2014; Onibokun et al., 2000).

In the Vanguard Newspaper of 2nd April 2014, LAWMA confirmed that Lagos Metropolis generates large quantities of waste to the tune of 10,000 to 12,000 metric tons per day. This has resulted in blockage of drainages, flooding and poor air quality due to bad habit of throwing wastes from their cars and still dumping wastes in unauthorized areas (Akoni, 2014). Many compounds are hemmed in by solid waste; the highways are not left out, which contribute to traffic bottlenecks and environmental pollution.



**Fig. 1.** Uncollected household waste on a street

Lagos State still embraces the open land fill disposal method and unfortunately none of the waste is sorted before disposal. The application of circular economy requires a rethink about the way we currently consume product and services, reuse material through their lifecycle, redesigning waste out of the industrial economy. In 2015, over 23 million inhabitants of Lagos produce large amount of waste in form of paper, cardboard, plastics, metal, food and other materials which can be recycled making many scavengers earn a difficult and potentially hazardous livelihood by searching the landfill site for the materials (Akoni, 2015). To effectively manage waste in any environment, the first step is the proper characterization of the waste in terms of quantity, composition and the source of generation. This study aimed to characterize the composition of domestic waste at source of generation, the rate of generation and collection in four Local Government Areas of the State.

## **2. Material and methods**

### *2.1. Description of the study area*

Domestic waste for this study is defined as the waste generated by the activities of families at their homes. The study area covers four (4) Local Government Areas (LGAs) of

the State. These settlements are classified according to the category of the inhabitants and their population densities.



**Fig. 2.** Uncollected market waste



**Fig. 3.** Uncollected waste on the highway

The settlements are Lagos Island in Lagos Island LGA, Ojodu in Ikeja LGA, Baiga in Somolu LGA and Agric in Ikorodu LGA. The population census of Lagos State is 9113,605 (Population Statistics, 2006). The study area was categorized according to Lagos State Ministry of Physical Planning & Urban Development (Handbook, 1999), as follows:

*Planned Settlement:* This was also subdivided into two, based on low and high density zones: (i) *Low density zone:* Lagos Island LGA. This is the principal and central local government area in Lagos, population of 212,700 (ii) *High density zone:* Ojodu (Ikeja LGA). Ikeja is the state capital of Lagos State with a population of 317,614

*Unplanned Settlement:* This was also subdivided into two based on low and high density zones: (i) *Low density zone:* Bariga (Somolu LGA). Population of Somolu Local government area is 403,569; (ii) *High density zone:* Agric (Ikorodu LGA). Ikorodu is a city located North East of the state along the Lagos Lagoon. It shares boundary with Ogun State and has a population census of 527,917.

## 2.2. Sample collection

Thirty waste samples were taken randomly from each Local Government Area according to the number of residents chosen for the study. Each of the samples was emptied into a polythene sheet (1 meter square) laid on the bare floor for sorting, weighed (wet weight) with Kwonnee balance (20 kilograms) model TN – 1741874 and sorted into categories, as recommended by the American Society for Testing and Materials (ASTM, 1998) test method D5231-92 (1998). The total wet weight of each waste category was determined and expressed in gram. The whole process of sorting and weighing was carried out four times a week in every two months between January 2013 and December 2015. From the data collected, it was possible to determine the quantities of waste generated per day per person and also the percentage composition of each waste constituent.

## 2.3. Waste collection

Waste data was collected from the Olusosun dumpsite for a period of two years between January 2013 and December 2015. The dumpsite is the disposal point for the selected study area. The dumpsite is located at Ojota in Kosofe LGA of Lagos State. It covers about 42 acres of land with maximum depth of 15 meters. It is the largest of the three dumpsites in operation in Lagos State Lagos State Waste Management Authority, Landfill Gate Records (Handbook, 2004). Quantities of waste in dump trucks were determined in-situ at the dumpsite with the use of Weight Bridge.

### 3. Results and discussion

#### 3.1. Composition of waste

The composition of waste varies from one local government areas to another (Table 1). Agric in Ikorodu Local Government area has the highest food waste and the lowest glass because is of unplanned high density area. While Lagos Island the planned low density area has the lowest food waste and the highest glass. The packages are more in planned areas than the unplanned because of process food (Figs. 4, 5). Nylon is higher in the unplanned areas due to lack of portable water that make the residents depend on sachet water.

**Table 1.** Mean composition (g) of domestic waste from Lagos Metropolis

<i>Waste Composition</i>	<i>Lagos Island</i>	<i>Ojodu</i>	<i>Bariga</i>	<i>Agric</i>	<i>Mean</i>
Food Waste	1323.32	1354.22	1540.63	1627.33	1461.38
Metal	59.31	93.88	68.64	42.86	66.18
Textile	118.23	114.14	99.54	72.60	101.13
Plastics	135.87	130.10	115.55	100.62	120.53
Glass	62.09	52.86	52.79	41.31	52.26
Paper	240.33	224.08	217.31	204.11	221.46
Nylon	152.56	164.34	209.68	223.3	187.47
Mean	298.82	304.80	329.16	330.30	315.77

\* Mean of 840 components of domestic waste samples

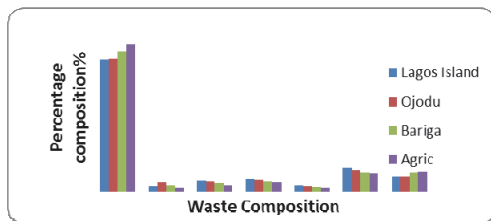

**Fig. 4.** Percentage composition of domestic waste in the four local government areas of Lagos Stat

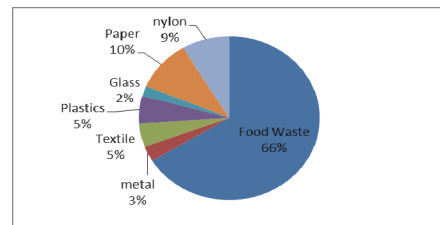

**Fig. 5.** Percentage composition of domestic waste in Lagos metropolis

The percentage composition for each of the Local Government Areas shows that Ikoyi has the lowest value of food waste. This can be explained according to Cointreau – Levine (1997) that higher income and economic growth have an impact on the composition of wastes. Wealthier individuals consume more packaged products, which result in a higher percentage of inorganic materials in the waste stream. In the case of planned areas (Lagos Island and Ojodu) most residents depend on processed food while those from unplanned areas (Bariga and Agric) rely more on unprocessed food for cooking at home, thus generating a significant amount of food waste. Bolaane and Ali (2004) reported that the packaging fractions of household waste have a direct relationship with household income. Likewise in this study, the packaging materials (paper, plastic, glass and metal) from Lagos Island, Ojodu, and Bariga are higher than those of Agric. The low value of packaging materials from Lagos Island, when compared with Ojodu and Bariga may be due partly to the accessibility of scavengers to waste bins that are usually placed outside the gates of buildings.

#### 3.2. Waste generations per capita per day

Under the planned settlement category, Lagos Island has the highest generation rate which is attributable to the fact that the settlement is mainly inhabited by high income group compared to Ojodu which has more of middle income group (Table 2). For the unplanned

category, Bariga has the highest rate of generation because it is averagely inhabited by the middle income group, unlike the low income group of Agric. Wealthier individuals consume more than lower income earners, which results in higher waste generation rate for the former (Cointreau-Levin, 1997).

### 3.3. Waste collection

The mean weight of waste collected from the four Local Government Areas by the four Agents responsible for the municipal solid waste collection and disposal in Lagos State indicated that Ikorodu has the highest generation rate because it is the most highly populated settlement. This shows that the rate of collection depends on the rate of generation of waste, which also depends on the population of a particular settlement (Odunaiya, 2002). The total mean waste collected in Ikorodu is the highest of all the settlements, due largely to the fact that it is the most densely populated settlement in the study area (Table 3).

**Table 2.** Average solid waste generated (g) / capita / day

Day	Local Government Area				Mean	Std. Dev.
	Lagos Island	Ojodu	Bariga	Agric		
1	576.21	567.11	496.44	471.78	527.89	38.71
2	578.32	568.48	499.75	471.87	529.61	30.44
3	582.12	561.49	481.93	474.32	524.97	24.22
4	577.33	562.93	496.77	472.44	527.37	39.20
5	573.81	567.44	493.21	472.31	526.69	34.02
6	583.11	564.67	489.45	471.69	527.23	34.03
7	575.44	562.92	486.96	473.27	524.65	43.30
8	576.41	564.88	499.21	470.88	527.85	183.49
9	573.29	564.37	494.37	475.82	526.96	29.66
10	575.56	568.34	484.55	472.73	525.30	31.10
11	578.69	567.28	497.88	474.37	529.56	20.66
12	574.62	564.66	494.37	475.55	527.30	32.89
13	577.84	565.45	489.78	473.29	526.59	22.50
14	574.93	564.72	490.74	475.20	526.40	39.57
15	576.98	566.30	487.94	472.94	526.04	16.96
16	575.93	567.05	497.66	472.06	528.18	20.20
17	574.65	564.81	495.56	474.45	527.37	27.64
18	578.44	567.03	497.78	476.54	529.95	37.26
19	576.46	565.31	497.53	478.65	529.49	39.44
20	577.08	567.55	497.55	473.67	528.96	11.25
21	574.87	564.97	496.74	477.44	528.51	26.03
22	576.82	562.88	489.47	473.05	525.56	23.33
23	578.54	567.03	497.54	478.11	530.31	23.33
24	575.84	568.11	487.76	474.63	526.59	30.77
25	578.44	563.94	493.85	472.65	527.22	33.25
26	577.81	562.73	494.47	472.43	526.86	21.42
27	581.12	565.52	496.33	478.44	530.35	15.15
28	578.43	563.22	496.50	474.88	528.26	38.00
29	576.90	562.45	497.44	478.90	528.92	37.81
30	578.23	563.87	495.30	474.33	527.93	18.18
Mean	579.40	565.25	493.83	474.29	528.19	42.20

Municipal solid waste collected by Agents from Lagos Island, Ikeja, Somolu and Ikorodu showed that LAWMA had the highest collection of waste from Ikorodu only, while the PSP has the highest in Somolu. The reason is that the Lagos State Government introduced a pilot scheme, which gave a mandate to the PSPs to operate fully in some



selected Local Government Areas which included the study areas. LAWMA operated fully in Ikorodu because of its large population and the problems of indiscriminate dumping of waste as well as the congested markets in the area.

**Table 3.** Average monthly weight (tons) of municipal solid waste collected from Lagos Island, Ikeja, Somolu and Korodu

<i>Local Government Areas</i>	<i>LAWMA</i>	<i>L/GOVT</i>	<i>HWM</i>	<i>PSP</i>	<i>Mean</i>	<i>Std Error</i>
Lagos Island	654.78	397.38	443.42	1945.96	860.39	245.02
Ikeja	644.59	452.32	398.47	2148.52	910.98	211.61
Somolu	1130.50	462.66	422.15	2642.22	1164.38	121.04
Ikorodu	5786.16	462.54	428.74	2145.33	2205.70	1108.40
Mean	2054.01	443.73	423.20	2245.57	1291.62	393.54

*Between Local Govt, F = 39.24\*, Between Agents, F = 36.38\*, \* = significant at 95%, LSD at 0.05 α= 223.41*

#### 4. Conclusions

Waste generated in Lagos State contains a large percentage of organic materials. The waste is also more dense and humid, due to the prevalent consumption of fresh fruits and vegetables, as well as unpackaged food which can be used for biogas and compost.

The remaining non-biodegradable materials can be reused or recycle. The most effective waste management method can be achieved by allowing the generator of waste to sort and package appropriately for collection instead of the current dumping of waste together for collection and final disposal at the dumpsite.

#### Acknowledgements

The authors thank Mr. O. Oresanya, former General Manager, Lagos State Waste Management Authority (LAWMA) for his advice and for making available to us valuable documents and also for granting us official permission to work at the Olusosun Dumpsite. Furthermore, our gratitude goes to Mr. Mike, Mr. Fadipe and Mr. Lanre Sonibare of the Olusosun Dumpsite for their co-operation and assistance.

#### References

- Akinmuleya O., (2006), Lagos State Waste Management Authority (LAWMA), *Alausa Alert*, 2, 19-22.
- Akoni O., (2014), Lagos generates 12,000 tonnes of garbage daily, *Vanguard Nigeria*, On line at: <http://www.vanguardngr.com/2014/07/lagos-generates-12000-tonnes-garbage-daily/>
- Akoni O., (2015), Lagos Waste Generation Hits 13,000 Metric Tonnes Daily. *Vanguard Nigeria*, On line at: <https://www.vanguardngr.com/2015/08/lagos-waste-generation-hits-13000-metric-tonnes-daily-lawma-boss/>
- ASTM, (1998), *Standard Test Method for Determination of the Composition of Unprocessed Municipal Solid Waste*, ASTM Standard D 5231-92, American Society for Testing and Materials, USA.
- Bolaane B., Ali M., (2004), Sampling household solid waste at source: Lessons learnt in Gaborone, *Journal of Waste Management & Research*, 22, 142-148.
- Cointreau-Levin S., (1997), Occupational and Environmental Health Issues of Solid Waste Management: Special Emphasis on Middle and Lower - Income Countries. (Draft), World Bank Report, Washington D.C.
- Handbook, (1999), *Lagos State Ministry of Physical Planning and Urban Development*, Local Government Areas and Communities of Lagos State, Government Publications, Lagos, Nigeria.
- Handbook, (2004), *Handbook of Lagos State Waste Management Authority (LAWMA)*, Landfill Gate Records, Ijora Head Office, Government Publications, Lagos, Nigeria.
- Onibokun A.G., Adedipe N.O., Sridlier M.K.C., (2000), *Affordable Technology and Strategies for Waste Management in Africa. Lessons and Experience*, Center for African Settlement Studies and Development, Ayo Adekunle Close, New Bodija Estate, Nigeria.
- Population Statistics, (2006), *Population Census 2006-03-21*, Lagos State, Nigeria, On line at: <https://www.citypopulation.de/php/nigeria-admin.php?adminid=NGA025>.



Procedia Environmental Science, Engineering and Management 4 (2017) (3) 149-154

21th International Trade Fair of Material & Energy Recovery and Sustainable Development,  
ECOMONDO, 7th-10th November, 2017, Rimini, Italy

---

## **ENVIRONMENTAL PRODUCT DECLARATION AS A STRATEGY TO APPLY BIO ECONOMY IN THE SUSTAINABLE STEEL SECTOR\***

**Marco Palmieri<sup>1</sup>, Federica Ragaglia<sup>1</sup>, Sebastiano Patanè<sup>1\*\*</sup>,  
Paolo Piana<sup>1</sup>, Carlo Ingrao<sup>2</sup>, Alberto Bertino<sup>3</sup>**

<sup>1</sup>*University of Catania, Department of Economics and Business- Corso Italia 55- 95129 Catania-Italy*

<sup>2</sup>*Facolta' Di Ingegneria E Architettura, Universita' Degli Studi Di Enna Kore,  
Cittadella Universitaria, 94100- Enna, Italy*

<sup>3</sup>*Acciaierie di Sicilia S.p.A., Via Passo Cavaliere, 1, 95121 Catania, Italy*

---

### **Abstract**

Over the years, the topic of environmental sustainability in products or processes has aroused a growing interest among stakeholders and supported the development of a green approach in the process of the circular economy in order to adopt the best strategies within the companies. Moreover, the environmental variable is not seen as a limit but a source of environmentally friendly products and services, offering a benefit compared to the competitors in the specific market. In particular the bio-construction sector is one of the most active sectors from an environmental point of view, especially after the approval of the Green Procurement Program (GPP), a program sanctioned by the European Union in order to guide the public authorities in purchasing procedures of greener products and services. ISO environmental certification requirements are part of this context because they are communication tools that inform people of the environmental sustainability of products and services. In this regard, the international Standard ISO 14020 specifies the general lines of three environmental labels, all based on the Life Cycle Assessment. One of these standards is the environmental label "III" or Environmental Product Declaration (EPD), which is a voluntary third-party certification tool that refers to the realistic information about the environmental performances of products or services. The company Acciaierie di Sicilia s.p.a. selected in the analysis conducted occupies a prominent position in the European steel industry and it is a leader in the market of southern Italy for the Alfa Acciai Group. Importance is given first to achieving elevated environmental performance, then to the adaptability and flexibility in the market context, to growing production and to organization efficiency. The company is now involved in a new mechanical approach in terms of ductility and environmental sustainability.

---

\*Selection and peer-review under responsibility of the ECOMONDO

\*\*Correspondence author: [sebastiano.patane97@hotmail.com](mailto:sebastiano.patane97@hotmail.com)

*Keywords:* Acciaierie di Sicilia, bio economy, environmental product declaration, Life Cycle Analysis, Steel industry

---

## **1. Introduction**

Construction sector has changed substantially in the last few decades of globalization; the major players in this sector in fact have felt the need to develop new strategies. This socio-economic phenomenon and the development of green economy, which has contributed to the development of more environmentally-friendly manufacturing processes, have led companies to implement proactive business policies and updated sustainable tools (certifications, trademarks, environmental methodologies) attesting the importance of the environment and giving the opportunity to communicate quantitatively and qualitatively, the efforts and the investments made in accordance with the environmental theme (Lavallée and Plouffe, 2004).

Moving in this direction, ISO proposed three categories of environmental labels according to the aspects covered and the rigor required achieve certification: type I (ISO 14024, 2002); type II (ISO 14021, 2001); and type III (ISO 14025, 2006), this paper will focus on EPD® (Environmental Product Declaration). This is a verified and registered document that communicates transparent, comparable information about the life-cycle environmental impact of products (<http://www.environdec.com/en/>). The EPD is part of one of the three voluntary eco-labels, as well as one dedicated to estimate the potential environmental impacts associated with the product life cycle. EPD contains information (objective, comparable and credible) about the environmental performance of the entire life cycle of products and services. It is an informative tool that covers all environmental aspects, potential impacts: design, manufacture, use and disposal. In this context, the Italian steel sector aims to contain emissions in any environmental system (air, water, soil) to use resources rationally, and manage plants in a sustainable manner their introduction into the territory today represents both a priority and a challenge that cannot be lost for the steel sector. (<http://www.federacciai.it>). Companies aiming at the highest quality of processes and products ensuring proper environmental ethics welcome these goals. Among them "Acciaierie di Sicilia" is the leader of the steel industry of Southern Italy (<http://www.alfaacciai.it>) which aims to achieving high environmental performance, making eco-compatibility and sustainability two of the main goals of its development for contemporary industrial competition.

This paper direct to obtain a complete and exhaustive analysis of the inventory to establish the appropriate tools for the company to implement the EPD through information and data obtained from the LCA.

## **2. Environmental Product Declaration**

The EPD system was introduced in Sweden in 1997 and is now one of the most successful initiatives in the international arena of environmental statements. This tool is used extensively in the European context; especially Italy which boasts the largest number of EPD certifications on the world market. The Environmental Product Declaration (EPD) product declaration is a tool representing the category covered by ISO 14025 Type III. It is applicable to all products or services regardless of their use or location in the production chain and is developed using the Life Cycle Assessment (LCA) as a methodology that allows identification, mapping and analysis of all environmental impacts of the finished product or service (Bribiàn et al., 2009).

EPD is the most effective tool for the spread of certified environmental information about the sustainability of the products, its application guarantees:

Objectivity: the information spread by the instrument must ensure verified valuations that allow emphasizing relevant product lifecycle data useful to internal and external stakeholders. Comparability: it is possible to compare several similar products belonging to the same sector. Credibility: the release of information is guaranteed by independent organizations, appropriately accredited, to validate them. Having satisfied the abovementioned requirements, EPD enables the positioning of its products in a distinctive way in the market, allowing the consumers and the commercial partners make responsible purchasing choices. The firm that adopts this tool strengthens its commitment toward sustainability and implements a system of continuous improvement of the environmental quality of its products and services. In such way, it improves its image inside the competitive context where it acts. The greatest present limit in the implementation of the EPD is represented by the partial evaluation of the cycle of life of the product (LCA) because it analyzes the finished product and its insertion inside the market of reference (Westkämper et al., 2001).

### **3. Experimental**

Steel is a major component material for a wide range of market applications and products, such as in the automotive, construction and packaging. Steel has life cycle advantages over competing materials because of its relatively low energy use, high recyclability, conservation of natural resources and the extensive re-use of by-products.

In order to obtain the EPD, the company examined must prepare, carry out and verify a LCA study applied to specific activities, first individualizing the reason / motivation why the study is being conducted, and then identifying the system to build the study on (with the appropriate limitations). The Life Cycle Inventory (LCI) analysis involves creating an inventory of flows from and to nature for a product system (Bribián et al., 2011). Inventory flows include inputs of water, energy, raw materials, and emission into the air, land, and water. To develop the inventory, a flow model of the technical system is constructed using data on inputs and outputs that subsequently can be the object of elaborations and comments, from which to make evaluations and useful indications on a decisional level.

The LCA type study in Acciaierie di Sicilia S.p.a. is aimed at inventory analysis in order to have all the useful information for the application of the EPD in the company. The study considers the entire production chain consisting of the following phases:

**UPSTREAM Process (A1):** Scrap Pretreatment, Cutting, Crushing, Sorting, Raw Materials and Power Generation. **Module (A2+A3):** Transportation of material, Billet Production, Hot Rolling Process, Packaging, Internal Treatment, Auxiliary Activities, Air Emissions, Water Emissions, Solid Waste) **DOWNSTREAM Process (A4):** Transport to the market. From the data provided by the company and from the analyses conducted by specialized companies in 2016 (the EPD is based on the data of the year preceding the drafting), the LCA Inventory of the plant was compiled, including qualitative and descriptive data about input inside the process in terms of: materials in the production process (Table 1), raw materials (Table 2), auxiliary materials (Table 3), energy (Table 4), emissions in air (Table 5), emissions in water (Table 6).

### **4. Results**

Life cycle impact assessment (LCIA) intend to understanding and quantifying the magnitude and significance of the potential environmental impacts of a product or a service throughout its entire life cycle. Understanding these impacts is the first step in prevention, reduction and remediation actions. (<http://www.lc-impact.eu/>). LCIA studies the significance of environmental impacts of the product, building a model based on category indicators of the impacts associated with emissions, obtained through conversion of inventory results. This

phase is intended to evaluate the contribution that the product brings to the individual impact categories, like Global warming, acidification, water eutrophication etc.

**Table 1.** Main materials and substances used in the production process

<i>Main materials and substances</i>	<i>Application</i>
Antracite	steel coating
Calcium oxide	slag
Ferroalloys	calibration chemical chemical composition
Oxygen (gas)	burning and fluidizing steel casting
Nitrogen	mixing steel casting and technical gas for valve movement
Electrodes	fusion
Recarburizers	steel coating

**Table 2.** Raw materials input Steelworks plant 2016

<i>Substance</i>	<i>Quantity</i>
Scrap (TOTAL)	tons
Cast iron	tons
Ferroalloys	tons
(Fe - Si - Mn)	tons
(Fe - Si )	tons
Lime	tons
Coke	kg
Anthracite	kg
Melting electrodes	kg

**Table 3.** Auxiliary materials used in the company for the Steelworks 2016 plant

<i>Material</i>	<i>Concentration or purchase composition</i>
Oxygen (m <sup>3</sup> )	
Lubricants (kg)	municipalities for the whole plant allocated on production
Refractory (kg)	
Argon (m <sup>3</sup> )	
Water from the net (m <sup>3</sup> )	process
	civil
Nitrogen (m <sup>3</sup> )	
Propane (kg)	

The objective is to capture consumption and emissions in the LCI to specific impact categories, related to known environmental effects (classification). This operation can lead to a ranking or a hierarchy of classes of impact with respect to their importance and provide a structure that can help to draw conclusions on the relative importance of different impact categories.

**Table 4.** Energy consumed by the steel industry in 2016

<i>Energy consumed</i>	<i>Unit</i>
Natural gas	m <sup>3</sup> /year
Electricity from the network	(kWh / year)
Diesel not for external transport	(L/ year)

**Table 5.** Total air emissions into air plant Acciaieria 2016

<i>Substance</i>	<i>Unit</i>
Cadmium	mg/m <sup>3</sup>
Total Chromium	mg/m <sup>3</sup>
Chromium VI	mg/m <sup>3</sup>
Manganese	mg/m <sup>3</sup>
Mercury	mg/m <sup>3</sup>
Nickel	mg/m <sup>3</sup>
Lead	mg/m <sup>3</sup>
Total powders	mg/m <sup>3</sup>
Copper	mg/m <sup>3</sup>
CO <sub>2</sub>	t/year
HCl	mg/m <sup>3</sup>
HF	mg/m <sup>3</sup>

**Table 6.** Emissions into water (after treatment)

<i>Indicator</i>	<i>Unit</i>
COD	mg / L
BOD	mg / L
Total Suspended Solids	mg / L
Organic Substances (Total Hydrocarbons)	mg / L
Zinc	mg / L
Iron	mg / L
Nickel	mg / L
Copper	mg / L
Total surfactants	mg / L
Lead	mg / L
Chrome	mg / L
Cadmium	mg / L
Manganese	mg / L
Nitrite	mg / L
Nitrate	mg / L
Chloride	mg / L
Sulphate	mg / L
Total phosphorous	mg / L
Total nitrogen	mg / L
Total cyanides	mg / L
IPA	mg / L
Organostannic compounds	mg / L

Tables 1-6 also provide information on emissions from the company's production cycle that identify the environmental performance of the product inside the mill and roller. Such detailed information (in terms of energy consumed, air emissions and water emissions) are estimates results.

## 5. Conclusions

The EPD brand represents an excellent corporate policy tool for all those companies that intend to enter the world of the Green Economy. It has been designed to differentiate products and services that take account of the environmental performance of products, allow customers to make responsible choices. To achieve this goal a complete inventory analysis (LCI) is require and an environmental emission quantification (LCIA).



Businesses that choose to adopt an eco-sustainable business policy affect the actions and policies adopted by the various stakeholders by changing the context in which they operate. Specifically, Acciaierie di Sicilia is an emblematic case of a proactive company which, by supporting a "green" strategy using credible certification, has been able to bring economic benefits to Sicilian suppliers first, primarily purchasing their scrap and advantages in terms of technical-productive efficiency, thanks to the study of the environmental impacts of the products. In recent years, Acciaierie di Sicilia has pledged to improve the environmental performance of its production process with various measures, installing a new gas filtration system in August 2010; a new suction hood, integrated with carbon input installation activated in February 2012. Both systems provide better environmental performance in terms of atmospheric emissions. EPD, besides being a useful safeguard for consumer communication with consumer protection, is also a valid support tool for decisions taken by management to implement actions that minimize environmental impact during all the phases of productive cycle.

Steel's contributions to helping achieve the triple bottom line of environmental, economic and societal sustainability make it vital to achieving the needs of today without impacting society's ability to meet the needs of the future. While competing materials focus their sustainability claims on specific phases of product application, steel's superior sustainability performance minimizes environmental impact when measured through the entire life cycle.

## References

- Bribián I., Usón A., Scarpellini S., (2009), Life cycle assessment in buildings: State-of-the-art and simplified LCA methodology as a complement for building certification, *Building and Environment*, **44**, 2510-2520.
- Bribián I., Capilla A., Usón A. (2011), Life cycle assessment of building materials: Comparative analysis of energy and environmental impacts and evaluation of the eco-efficiency improvement potential, *Building and Environment*, **46**, 1133-1140.
- ISO 14024, (2002), *Type I environmental labelling – Principles and procedures*, ISO 14024:2002, International Standardization Office, Genève, Switzerland.
- ISO 14021, (2001), *Environmental labels and declarations – Self-declared environmental claims*, ISO 14021:2001, International Standardization Office, Genève, Switzerland.
- ISO 14025, (2006), *Environmental labels and declarations – Type III environmental declarations*, ISO 14025:2006, International Standardization Office, Genève, Switzerland.
- Lavallée S., Plouffe S., (2004), *The ecolabel and sustainable development*, *The International Journal of Life Cycle Assessment*, **9**, 349-354.
- Westkämper E., Alting L., Arndt G., (2001), Life cycle management and assessment: approaches and visions towards sustainable manufacturing, *Proceedings of the Institution of Mechanical Engineers, Part B: Journal of Engineering Manufacture*, **215**, 599-626.

## Websites

- <http://www.environdec.com/en/>
- [http://www.federacciai.it/wp-content/uploads/2016/11/Rapporto\\_Ambientale\\_2011.pdf](http://www.federacciai.it/wp-content/uploads/2016/11/Rapporto_Ambientale_2011.pdf)
- <http://www.alfaacciai.it/acciaierie-di-sicilia/>
- <http://www.lc-impact.eu/methodology-home>



## **HYDROGEN PRODUCTION FROM FOOD WASTE USING BIOCHEMICAL HYDROGEN POTENTIAL TEST\***

**Isabella Pecorini\*\***, Francesco Baldi<sup>2</sup>, Elena Albini<sup>2</sup>, Giovanni Galoppi<sup>1</sup>,  
Donata Bacchi<sup>2</sup>, Andrea Della Valle<sup>1</sup>, Andrea Baldi<sup>1</sup>, Alessandro Bianchini<sup>1</sup>,  
Alfonso Figini<sup>2</sup>, Patrizia Rossi<sup>1</sup>, Paola Paoli<sup>1</sup>, Carlo Carcasci<sup>1</sup>, Giovanni  
Ferrara<sup>1</sup>, Ennio Antonio Carnevale<sup>1</sup>

<sup>1</sup>*DIEF, Department of Industrial Engineering, University of Florence,  
Via di S. Marta 3, 50139 Firenze, Italy*

<sup>2</sup>*PIN S.c.r.l. – Servizi didattici e scientifici per l'Università di Firenze,  
Polo Universitario "Città di Prato", Piazza G. Ciardi 25,*

---

### **Abstract**

The bio-hydrogen production from food waste was evaluated by means of experimental analysis and kinetic model. Biochemical hydrogen potential tests and the application of the modified Gompertz equation were performed. Batch test results showed a production of 48.9  $\text{NIH}_2/\text{kgTVS}_{\text{sub}}$  while the kinetic model well fitted the experimental curve with a correlation coefficient of 0.998. Experimental and model data fell within the range reported by previous researches on bio-hydrogen production from food waste.

*Keywords:* biochemical hydrogen potential, food waste, Gompertz equation, hydrogen

---

### **1. Introduction**

The renewed interest in anaerobic digestion (AD) of biodegradable residues has prompted the scientific community to a further development of the process. For instance, bio-hydrogen production during the acidogenic phase of AD is nowadays regarded as a key topic by many researchers due to its potential benefits on both energy and environmental balance (Ghimire et al., 2015, Khan et al., 2016). Hydrogen has gained interest because of its

---

\*Selection and peer-review under responsibility of the ECOMONDO

\*\* Corresponding author: e-mail: Isabella.pecorini@unifi.it

eco-friendly nature since it is a carbon-free clean fuel (Kotay and Das, 2008) and because of its versatility as it can be used either in combustion engines or converted to electricity (Alves et al., 2013). Several organic substrates have been tested for biohydrogen production (Ghimire et al., 2015) and food waste (FW) seems to be a valuable feedstock because of its biodegradability characteristics and availability (Cavinato et al., 2011, 2012; Chinellato et al., 2013; Han and Shin, 2004; Micolucci et al., 2014). Indeed, FW is a major fraction of municipal solid waste since it is largely produced in residential areas and its employment in conventional AD is already a well-established technology.

In order to have a rapid, low cost and valuable response of hydrogen production of a substrate, Biochemical Hydrogen Potential (BHP) tests are used in literature (Alibardi and Cossu, 2015; Alibardi and Cossu, 2016; Argun et al., 2008; Cappai et al., 2014; Chinellato et al., 2013; Giordano et al., 2011). BHP tests consist in batch reactors where a certain amount of substrate is incubated with an inoculum under anaerobic fermentative conditions. Batch tests are mostly preferred when time and costs are a constraint due to their simplicity and less time-consuming procedure in comparison with more complex and high-priced continuous reactor experiments. BHP assays evaluate the specific amount of hydrogen that can be potentially produced when a certain substrate or waste is biodegraded under fermentative conditions and it is usually expressed as  $\text{NIH}_2/\text{kgTVS}_{\text{added}}$ . In particular, BHP tests play a fundamental role as previous experimental tests to assess the potential, adequacy and viability of the dark fermentative treatment of such wastes of interest (Holliger et al., 2016; Wang and Wan, 2009; Zumar Bundhoo et al., 2015; Zumar Bundhoo and Mohee, 2016).

In this study, biohydrogen production from FW was evaluated through BHP assays using two types' set-ups.

## 2. Materials and methods

### 2.1. Food waste and inoculum characterization

FW was collected from the Organic Fraction of Municipal Solid Waste (OFMSW). In order to obtain a slurry with a total solid (TS) content suitable to wet fermentation, the sample was treated in a food processor, sift with a strainer (3 mm diameter) and mixed with tap water. Activated sludge (AS) from the aerobic unit of a municipal wastewater treatment plant was used as inoculum (Angeriz-Campoy et al., 2015; Favaro et al., 2013). A first characterization of FW and WS, taking into account TS, TVS and pH results is presented in Table 1.

**Table 1.** Food waste and inoculum characterization  
(pH, TS and TVS/TS are expressed by mean and standard deviation)

<i>Material</i>	<i>TS (%)</i>	<i>TVS/TS (%)</i>	<i>pH</i>
FW	5.6 ± 0.1	91.6 ± 0.3	3.81 ± 0.01
AS	1.5 ± 0.1	78.6 ± 0.3	7.08 ± 0.01

### 2.2 Analytical parameters

FW and AS were studied through physico-chemical, bromatological and methane potential analysis. TS, TVS and pH were determined in order to characterize inoculums and FW according to standard methods (APHA, 2006). Due to the acidic condition of each substrate, TS determination was performed at 90°C instead of 105°C until constant weight in order to avoid the volatilization of VFA.

Proteins, lipids, cellulose, Total Kjeldahl Nitrogen (TKN) contents were measured in accordance with the European Commission Regulation 152 (European Commission, 2009). Carbohydrates were then calculated by subtracting to the total amount, the contents of humidity, ashes, proteins, lipids and fibers. Lignin was measured according to MP 0424 (2010). Concerning the elementary composition C, H, N were obtained following EN 15407 (2011), while S and P were measured using EPA 6010 D (2014) and EN 13657 (2004). The oxygen content was estimated by subtracting the sum of C, H, N, S and P from the total. Ammonia was measured according to APHA (2012) while Total Organic Carbon (TOC) was measured thanks to Decreto Ministeriale 196 (1989). Volatile Fatty Acids (VFAs, including acetic, propionic, butyric, iso-butyric, valeric and iso-valeric acids) were measured according to MP 0224 (2012) while total alkalinity was obtained through MP 1635 (2013). FW was also characterized in terms of methane production by means of BMP tests following the procedure of Pecorini et al. (2016).

### *2.3 Experimental set-up*

The analyses were conducted based upon the method described by Alibardi and Cossu (2015). The test was performed in triplicate using 1 l stainless steel batch reactors (Pecorini et al., 2016). The vessels were placed on a magnetic stirred and incubated in a water bath at 37°C for 2 days. The ratio between the volatile solids of the substrate to be degraded and volatile solids of the inoculum biomass (Food/Microorganism, F/M) was 0.5 gTVS/gTVS. The working volume of the bottle was approximately 0.5 l and consisted of inoculum, substrate, MES (2-N-Morpholino-EthaneSulfonic acid, VWR, Italy) buffer solution and HCl 2.5M to set the initial pH at 5.5. After set-up, the bottles were flushed with N<sub>2</sub> for few minutes to ensure anaerobic conditions in the headspace of the batches. The inoculums were previously heat-treated at 80°C for 30 minutes with the aim to select only hydrogen producing bacteria and inhibit hydrogenotrophic methanogens (Alibardi and Cossu, 2015; Jung et al., 2011; Li and Fang, 2007).

Biogas production was periodically estimated by measuring the pressure in the headspace of each reactor and then converting to volume by the application of the ideal gas law. Pressure was measured using a membrane pressure gauge (Model HD2304.0, Delta Ohm S.r.L., Italy). The measured values of pressure were converted into biogas volume by Eq. (1):

$$V_{biogas} = \frac{P_{measured} T_{NTP}}{P_{NTP} T_r} V_r \quad (1)$$

where:  $V_{biogas}$  - volume of daily biogas production, expressed in Normal liter (NL);  $P_{measured}$  - headspace pressure before the gas sampling (atm);  $T_r$  and  $V_r$  - temperature (K) and volume (L) of the reactor's headspace;  $T_{NTP}$  and  $P_{NTP}$  - normal temperature and pressure (273.15 K and 1 atm respectively).

The BHP was determined as the cumulated hydrogen production divided by the TVS content contained in each batch. In order to determine the hydrogen production, the hydrogen content of the gas was measured by using gas chromatography (3000 Micro GC, INFICON, Switzerland).

### *2.4 Kinetic model*

The mean cumulative hydrogen production curves were obtained over the course of the batch experiment and analysed using the modified Gompertz equation (Van Ginkel et al., 2005). Eq. (2) is used in many works to describe the kinetic of hydrogen production from

batch fermentation assays (Pan et al., 2008).

$$H(t) = H_{max} \exp \left\{ - \exp \left[ \frac{R \cdot e}{H_{max}} (\lambda - t) \right] + 1 \right\} \quad (2)$$

where:  $H(t)$  - hydrogen production at a time  $t$  (NL  $H_2$ /kgTVSsub);  $H_{max}$  - total amount of hydrogen produced (NL  $H_2$ /kgTVSsub);  $R$  - maximum hydrogen production rate (NL  $H_2$ /kgTVSsub h);  $\lambda$  - length of the lag phase (h).

The time needed to attain 95% of the maximum hydrogen yield ( $t_{95}$ ), was obtained from the Gompertz equation as follows (Cappai et al., 2014) (Eq. 3):

$$t_{95} = \frac{H_{max}}{R \cdot e} (1 - \ln(-\ln 0.95)) + \lambda \quad (3)$$

Constants were estimated by minimizing the sum square of errors between the experimental data and results of the model. The estimations were carried out by using the solver function of Microsoft Excel version 2016.

### 3. Results and discussion

#### 3.1. Analytical characterization of FW and inoculums

Table 2 presents the measured data of chemical, bromatological and methane potential analysis. Butyric, iso-butyric valeric and iso-valeric acids contents were not shown since they were found below the limit of detection (LOD = 40 mg/L). Acetic acid was the prevalent VFA for both AS and FW.

**Table 2.** Chemical, bromatological and methane potential data expressed by mean and standard deviation

<i>Parameter</i>	<i>AS</i>	<i>FW</i>
TOC (%C w/w)	1.2 ± 0.2	1.9 ± 0.2
TKN (%N w/w)	0.2 ± 0.0	0.2 ± 0.0
Ammonia (mgN/kg)	341 ± 47	191 ± 5
Acetic acid (mg/L)	830 ± 120	958 ± 30
Propionic acid (mg/L)	390 ± 71	< 40
C (%TS)	58.9 ± 4.3	36.0 ± 1.9
H (%TS)	6.4 ± 0.5	5.8 ± 0.2
N (%TS)	7.5 ± 0.9	2.9 ± 0.3
S (%TS)	0.9 ± 0.1	0.2 ± 0.0
P (%TS)	0.4 ± 0.1	0.4 ± 0.1
O (%TS)	27.9	54.6
Proteins (% w/w)	0.9 ± 0.1	1.0 ± 0.1
Lipids (% w/w)	< 0.3	0.5 ± 0.0
Carbohydrates (% w/w)	0.0	2.4
Cellulose (% w/w)	0.1 ± 0.0	0.8 ± 0.1
Lignin (% w/w)	0.3 ± 0.0	0.3 ± 0.1
BMP (NICH <sub>4</sub> /kgTVSsub)	-	511.6 ± 38.2

With regard to the C:N ratio, FW showed a value of 12.4, slightly below other FW findings: Zhang et al. (2007) reported an average value of 14.8 while Pan et al. 2008 and Han

and Shin 2004 obtained C:N ratios of 17.1 and 14.7 respectively. The C:N result found for AS (7.9) is concurring with previous researches and it is explained by the high N content and the high ammonia concentration (Table 2). In general the C:N ratio of sludge ranges between 6-9 (Iacovidou et al., 2012). C:N ratios lower than 6 negatively affect the digestion process mostly due to the low carbon availability in combination with high ammonia concentration that can cause toxicity to anaerobic bacteria (Iacovidou et al., 2012; Salerno et al., 2006).

The methane yield obtained for FW (511.6 NL CH<sub>4</sub>/kgTVS<sub>sub</sub>) was higher than values reported by Zhang et al. (2007), who obtained 435 NL CH<sub>4</sub>/kgTVS at 50°C and 28 days and Heo et al. (2004) who obtained 489 NL CH<sub>4</sub>/kgTVS at 35°C and 40 days.

Among the macromolecules, carbohydrates were the main component for FW while AS highlighted a predominance of proteins (Wilson and Novak, 2008). FW proteins and carbohydrates were found slightly below previous works probably due to the dilution employed in the present study (Table 3).

**Table 3.** Comparison of proteins and carbohydrates results of FW with previous studies

<i>Reference</i>	<i>Substrate</i>	<i>Proteins (g/kg)</i>	<i>Carbohydrates (g/kg)</i>
Present study	FW	10	24
Chu et al., 2008	FW	41-49	60-72
Lee et al., 2010	FW	1	35
Yeshanew et al., 2016	FW	31	134

### 3.2. BHP tests

Fig. 1 and Table 4 present the cumulative hydrogen production over time and the kinetic parameters calculated using Gompertz Equation. Hydrogen production was observed until 47 h. After this period, the cumulative curve highlighted a decreasing trend owing to biological hydrogen consumption (De Gioannis et al., 2013, 2017). The inoculum heat pre-treatment prior to the DF process was effective since methane content in biogas was detected null along all the duration of the tests (Zumar Bundhoo et al., 2015; Zumar Bundhoo and Mohee, 2016). As such, hydrogen consumption is probably attributable to propionic fermentation (Dong et al., 2010) or homoacetogenesis (De Gioannis et al., 2017; Saady, 2013). The final production of  $48.9 \pm 4.3$  NL H<sub>2</sub>/kgTVS<sub>sub</sub> fell within the range reported by previous works for FW. Alibardi and Cossu (2015) determined final results in the range of 25-85 NL H<sub>2</sub>/kgTVS<sub>sub</sub>, while Pecorini et al. (2017) and De Gioannis et al. (2017), reported hydrogen productions of 55.0 and 56.5 NL H<sub>2</sub>/kgTVS<sub>sub</sub> respectively.

Concerning the kinetic, the Gompertz model fitted well the experimental data with a high correlation coefficient (0.998). The kinetic parameters fell in the range of previous works (Table 4). The lag phase lasted few hours (3.4 h) while the time needed to attain 95% of the maximum hydrogen yield (*t*<sub>95</sub>) was reached after approximately one day (29.3 h) (Fig. 3).

**Table 4.** Experimental and model results

<i>Reference</i>	<i>BHP (NL H<sub>2</sub>/kgTVS<sub>sub</sub>)</i>	<i>R (NL H<sub>2</sub>/kgTVS<sub>sub</sub>h)</i>	<i>λ (h)</i>	<i>t<sub>95</sub> (h)</i>	<i>R<sup>2</sup></i>
Present study	48.9 ± 4.3	2.8	3.4	29.3	0.998
Cappai et al., 2014	77.5	7.2	6.2	22.1	-
Cappai et al., 2014	56.7	7.8	13.3	23.9	-
Cappai et al., 2014	117.6	16.6	3.9	14.3	-
De Gioannis et al., 2017	56.5	3.8	4.1	26.4	0.988
Pan et al., 2008	39	-	4.4	-	0.988



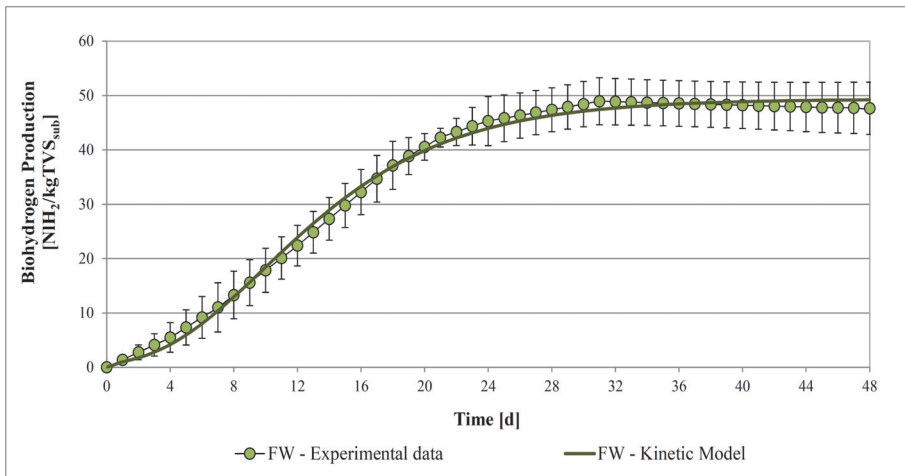

**Fig. 1.** Hydrogen production over time. Solid lines indicate Gompertz model curves. Y-error bars represents standard deviation.

#### 4. Conclusions

The bio-hydrogen production from food waste was evaluated by means of experimental analysis and kinetic model. Biochemical hydrogen potential tests and the application of the modified Gompertz equation were performed. Batch test results showed a production of 48.9 NIH<sub>2</sub>/kgTVS<sub>sub</sub> while the kinetic model well fitted the experimental curve with a correlation coefficient of 0.998. Experimental and model data fell within the range reported by previous researches on bio-hydrogen production from food waste.

#### Acknowledgements

This project has been funded with support from the MIUR-MISE-Regione Toscana DGRT 758/2013 PAR FAS 2007-2013. The authors want to thank the support of SEA Risorse and Alia S.p.A. for providing the waste samples.

#### References

- Alibardi L., Cossu R., (2015), Composition variability of the organic fraction of municipal solid waste and effects on hydrogen and methane production potentials, *Waste Management*, **36**, 147-155.
- Alibardi L., Cossu R., (2016), Effects of Carbohydrate, protein and lipid content of organic waste on hydrogen production and fermentation products, *Waste Management*, **47**, 69-77.
- Alves H.J., Bley Junior C., Niklevicz R.R., Frigo E.P., Frigo M.S., Coimbra-Araújo C.H., (2013), Overview of hydrogen production technologies from biogas and the applications in fuel cells, *International Journal of Hydrogen Energy*, **38**, 5215–5225.
- Angeriz-Campoy R., Alvarez-Gallego,C.J., Romero-García L.I., (2015), Thermophilic anaerobic co-digestion of organic fraction of municipal solid waste (OFMSW) with food waste (FW): enhancement of bio-hydrogen production, *Bioresource Technology*, **194**, 291-296.
- APHA, (2006), Standard Methods for the Examination of Water and Wastewater, On line at: [https://www.mwa.co.th/download/file\\_upload/SMWW\\_1000-3000.pdf](https://www.mwa.co.th/download/file_upload/SMWW_1000-3000.pdf).
- APHA, (2012), APHA 4500 NH<sub>3</sub> B/C – *Ammonia-Selective Electrode Method*, On line at: [https://beta-static.fishersci.com/content/dam/fishersci/en\\_US/documents/programs/scientific/technical-documents/white-papers/apha-ammonia-ise-white-paper.pdf](https://beta-static.fishersci.com/content/dam/fishersci/en_US/documents/programs/scientific/technical-documents/white-papers/apha-ammonia-ise-white-paper.pdf).
- Argun H., Kargi F., Kapdan I.K., Oztekin R., (2008), Biohydrogen production by dark fermentation of wheat powder solution: effects of C/N and C/P ratio on hydrogen yield and formation rate, *International Journal of Hydrogen Energy*, **33**, 1813-1819.

- Cappai G., De Gioannis G., Friargiu M., Massi E., Muntoni A., Polettini A., Pomi R., Spiga D., (2014), An experimental study on fermentative H<sub>2</sub> production from food waste as affected by pH, *Waste Management*, **34**, 1510-1519.
- Cavinato C., Bolzonella D., Fatone F., Cecchi F., Pavan P., (2011), Optimization of two-phase thermophilic anaerobic digestion of biowaste for hydrogen production and methane production through reject water recirculation, *Bioresource Technology*, **102**, 8605-8611.
- Cavinato C., Giuliano A., Bolzonella D., Pavan P., Cecchi F., (2012), Bio-hydrogen production from food waste by dark fermentation coupled with anaerobic digestion process: a long-term pilot scale experience, *International Journal of Hydrogen Energy*, **37**, 11549-11555.
- Chinellato G., Cavinato C., Bolzonella D., Heaven S., Banks C.J., (2013), Biohydrogen production from food waste in batch and semi-continuous conditions: evaluations of a two-phase approach with digestate recirculation for pH control, *International Journal of Hydrogen Energy*, **38**, 4351-4360.
- De Gioannis G., Muntoni A., Polettini A., Pomi R., (2013), A review of dark fermentative hydrogen production from biodegradable municipal waste fractions, *Waste Management*, **33**, 1345-1361.
- De Gioannis G., Muntoni A., Polettini A., Pomi R., Spiga D., (2017), Energy recovery from one- and two-stage anaerobic digestion of food waste, *Waste Management*, **68**, 595-602.
- Decreto Ministeriale 196, (1989), Decreto Ministeriale 19 luglio 1989 n.196 – *Metodi ufficiali di analisi per i fertilizzanti Supplemento n.1.*, Ministero dell'Agricoltura e delle Foreste, Rome, Italy.
- Dong L., Zhenhong Y., Yongming S., Longlong M., (2010), Evaluation of pretreatment methods on harvesting hydrogen producing seeds from anaerobic digested organic fraction of municipal solid waste (OFMSW), *International Journal of Hydrogen Energy*, **35**, 8234–8240.
- EN 13657, (2004), Characterization of waste – Digestion for subsequent determination of aqua regia soluble portion of elements, EN 13657:2004, On line at: <http://ecommerce.sist.si/catalog/project.aspx?id=2db12457-71cd-4f00-b9bb-8eec93845c43>.
- EN 15407, (2011), Solid recovered fuels – Methods for the determination of carbon (C), hydrogen (H) and nitrogen (N) content, EN 15407:2011, On line at: <https://shop.bsigroup.com/ProductDetail/?pid=000000000030142938>.
- EPA 6010 D, (2014), Inductively coupled plasma/Optical emission spectrometry, On line at: [https://www.unil.ch/idyst/files/live/sites/idyst/files/shared/Labos/Hou%26Jones\\_2000.pdf](https://www.unil.ch/idyst/files/live/sites/idyst/files/shared/Labos/Hou%26Jones_2000.pdf).
- European Commission, (2009), European Commission Regulation 2009/152/EC of 27 January 2009 laying down the methods of sampling and analysis for the official control of feed, *Official Journal of the European Union*, L54, 1-130.
- Favaro L., Alibardi L., Lavagnolo M.C., Casella S., Basaglia M., (2013), Effects of inoculum and indigenous microflora on hydrogen production from the organic fraction of municipal solid waste, *International Journal of Hydrogen Energy*, **38**, 11774-11779.
- Ghimire A., Frunzo L., Pirozzi F., Trabaly E., Escudie R., Lens P.N.L., Esposito G., (2015), A review on dark fermentative biohydrogen production from organic biomass: process parameters and use of by-products, *Applied Energy*, **144**, 73-95.
- Giordano A., Cantù C., Spagni A., (2011), Monitoring the biochemical hydrogen and methane potential of the two-stage dark-fermentative process, *Bioresource Technology*, **102**, 4474-4479.
- Han S.-K., Shin H.-S., (2004), Biohydrogen production by anaerobic fermentation of food waste, *International Journal of Hydrogen Energy*, **29**, 569-577.
- Heo N.H., Park S.C., Kang H., (2004), Effects of mixture ratio and hydraulic retention time on single-stage anaerobic co-digestion of food waste and waste activated sludge, *Journal of Environmental Science Health*, **A 39**, 1739-1756.
- Holliger C., Alves M., Andrade D., Angelidaki I., Astals S., Baier U., Bougrier C., Buffière P., Carballa M., De wilde V., Ebertseder F., Fernandez B., Ficara E., Fotidis I., Frigon J.C., Fruteau de Lacroix H., Ghasimi D.S.M., Hack G., Hartel M., Heerenklage J., Horvath I.S., Jenicek P., Koch K., Krautwald J., Lizasoain J., Li J., Mosberger L., Nistor M., Oechsner H., Oliveira J.V., Paterson M., Pauss A., Pommier S., Porqueddu I., Raposo F., Ribeiro T., Pfund F.R., Stromberg S., Torrijos M., Van Eckert M., Van Lier J., Wedwitschka H., Wierinck I., (2016), Towards a standardisation of biomethane potential tests, *Water Science Technology*, **74**, 2515-2522.
- Iacovidou E., Ohandja D., Voulvoulis N., (2012), Food waste co-digestion with sewage sludge – realising its potential in the UK, *Journal of Environmental Management*, **112**, 267-274.
- Jung K.-W., Kim D.-H., Kim S.-H., Shin H.-S., (2011), Bioreactor design for continuous dark fermentative hydrogen production, *Bioresource Technology*, **102**, 8612-8620.

- Khan M.A., Ngo H.H., Guo W.S., Liu Y., Nghiem L.D., Hai F.I., Deng L.J., Wang J., Wu Y., (2016), Optimization of process parameters for production of volatile fatty acid, biohydrogen and methane from anaerobic digestion, *Bioresource Technology*, **219**, 738-748.
- Kotay S.M., Das D., (2008). Biohydrogen as a renewable energy resource – prospects and potentials, *International Journal of Hydrogen Energy*, **33**, 258–263.
- Li C., Fang H.H.P., (2007), Fermentative hydrogen production from wastewater and solid wastes by mixed cultures, *Critical Reviews in Environmental Science and Technology*, **37**, 1-39.
- Micolucci F., Gottardo M., Bolzonella D., Pavan P., (2014). Automatic process control for stable biohythane production in two-phase thermophilic anaerobic digestion of food waste, *International Journal of Hydrogen Energy*, **39**, 17563-17572.
- MP 0224, (2012), MP 0224 rev 2 2012 – *Volatile Fatty Acids*, On line at: <http://pa.sinal.it/PA59AR83.PDF>
- MP 0424, (2010), MP 0424 rev 5 2010 – *Lignin*, On line at: <http://pa.sinal.it/PA59AR83.PDF>.
- Pan J., Zhang R., El-Mashad R.H., Sun H., Ying Y., (2008), Effect of food to microorganism ratio on biohydrogen production from food waste via anaerobic fermentation, *International Journal of Hydrogen Energy*, **33**, 6968-6975.
- Pecorini I., Baldi F., Carnevale E.A., Corti A., (2016), Biochemical methane potential tests of different autoclaved and microwaved lignocellulosic organic fractions of municipal solid waste, *Waste Management*, **56**, 143-150.
- Pecorini I., Bacchi D., Albini E., Baldi F., Galoppi G., Rossi P., Paoli P., Ferrari L., Carnevale E.A., Peruzzini, M., Lombardi, L., Ferrara, G., (2017), *The Bio2Energy Project: Bioenergy, Biofuels and Bioproducts from Municipal Solid Waste and Sludge*, Proc. of the 25th Edition European Biomass Conference & Exhibition, 12-15 June 2017 Stockholm, Sweden.
- Saady N.M.C., (2013), Homoacetogenesis during hydrogen production by mixed cultures dark fermentation: Unresolved challenge, *International Journal of Hydrogen Energy*, **38**, 13172–13191.
- Salerno M.B., Park W., Zuo Y., Logan B.E., (2006), Inhibition of biohydrogen production by ammonia, *Water Resource*, **40**, 1167-1172.
- Van Ginkel, S.W., Oh S.-E., Logan B.E., (2005), Biohydrogen gas production from food waste processing and domestic wastewaters, *International Journal of Hydrogen Energy*, **30**, 1535-1542.
- Wang J., Wan W., (2009), Factors influencing fermentative hydrogen production: a review, *International Journal of Hydrogen Energy*, **34**, 799-811.
- Wilson C.A., Novak J.T., (2008), Hydrolysis of macromolecular components of primary and secondary wastewater sludge by thermal hydrolytic pretreatment, *Water Resource*, **43**, 4489-4498.
- Zhang R., El-Mashad H.M., Hartman K., Wang F., Liu G., Choate C., Gamble P., (2007), Characterization of food waste as feedstock for anaerobic digestion, *Bioresource Technology*, **98**, 929-935.
- Zumar Bundhoo M.A., Mohee R., Hassan M. A. (2015), Effects of pre-treatment technologies on dark fermentative biohydrogen production: a review, *Journal of Environmental Management*, **157**, 20-48.
- Zumar Bundhoo M.A., Mohee R. (2016), Inhibition of dark fermentative bio-hydrogen production: a review, *International Journal of Hydrogen Energy*, **41**, 6713-6733.



Procedia Environmental Science, Engineering and Management 4 (2017) (3) 163-171

21th International Trade Fair of Material & Energy Recovery and Sustainable Development,  
ECOMONDO, 7th-10th November, 2017, Rimini, Italy

---

## **OPTIMIZATION OF HYDROGEN AND METHANE PRODUCTION IN TWO-PHASE ANAEROBIC DIGESTION\***

**Isabella Pecorini<sup>1\*\*</sup>, Giovanni Ferrara<sup>1</sup>, Giovanni Galoppi<sup>1</sup>,  
Francesco Baldi<sup>2</sup>, Donata Bacchi<sup>2</sup>, Elena Albini<sup>2</sup>, Caterina Susini<sup>3</sup>,  
Alessia Scappini<sup>4</sup>, Lidia Lombardi<sup>5</sup>**

<sup>1</sup>*DIEF - Department of Industrial Engineering, University of Florence, Via Santa Marta 3, 50139  
Florence, Italy*

<sup>2</sup>*PIN S.c.r.l. – Servizi didattici e scientifici per l'Università di Firenze, Piazza G. Ciardi 25, 59100  
Prato, Italy*

<sup>3</sup>*SEA Risorse S.p.A. – Vietta dei Comparini 186, 55049 Viareggio (LU), Italy*

<sup>4</sup>*ALIA Servizi Ambientali S.p.A. – Via Baccio da Montelupo 52, 50142 Firenze, Italy*

<sup>5</sup>*UNICUSANO – University Niccolò Cusano - Via Don Carlo Gnocchi 3, 00166 Rome, Italy*

---

### **Abstract**

Bio2Energy project aims at improving the efficiency of public utility facilities such as wastewater treatment plants and increasing the production of renewable energy in Tuscany. The production of biohydrogen and biomethane from the co-digestion of Organic Fraction of Municipal Solid Waste (Food Waste, FW) and sewage waste sludge (WS) and the use of digestate as agricultural fertilizer are the main objectives that position the project within the Circular Economy Strategy. Anaerobic digestion is a proven technology for the production of renewable energy but this technology is even more interesting if it is exploited also for hydrogen production. Therefore, the production of biohydrogen occurring in the acidogenic phase could be associated with anaerobic digestion (AD) so as to generate two gas streams (H<sub>2</sub> and CH<sub>4</sub>), useful for different stakeholders, separately or mixed together. Our results revealed that the anaerobic co-digestion of sludge and food waste is an effective process able to produce energy self-sufficiency of wastewater treatment plants. Two-phase anaerobic digestion tests demonstrate the possibility to assess the production of hydrogen and methane in specific cases (sludge and food waste) and estimate the primary energy produced by different biogas users.

*Keywords:* anaerobic digestion; biohydrogen; biomethane; dark fermentation

---

\*Selection and peer-review under responsibility of the ECOMONDO

\*\* Corresponding author: e-mail: Isabella.pecorini@unifi.it

## **1. Introduction**

Transitioning to a more circular economy is an essential contribution to the EU's long-term efforts to advance a competitive, sustainable, low-carbon and resource-efficient economy (European Commission, 2017). Two-phase anaerobic digestion process obtained by the union of biohydrogen production during the acidogenic phase (named Dark Fermentation - DF) and biomethane production in AD, can be considered the new borders of AD process optimization (Ghimire et al., 2015).

Most of the conventional wastewater treatment plants (WWTPs) use AD for the treatment of the produced sludge by using digesters with spare capacity to face variation in wastewater flow and future population growth (Nghiem et al., 2017). Due to low organic loading and low biogas yields of sludge, energy recovery via anaerobic digestion in WWTPs is typically not sufficient to cover its energy consumption. Co-digestion of bio-waste with municipal sewage sludge is nowadays considered one of the most strategic approaches in waste and wastewater management thus increasing the energy production, reducing costs and facilitating nutrient recycling (Cavinato et al., 2013; Da Ros et al., 2014; Cavinato et al., 2014; Nghiem et al., 2017). Among the available substrates that have been tested for co-digestion, Food Waste (FW) is an optimum co-substrate in order to improve digestion efficiency of sewage sludge because of its readily biodegradable nature (Iacovidou et al., 2012). Furthermore, the co-digestion of these two substrates could be potentially suitable also for biohydrogen production from dark-fermentation. Indeed, due to their considerable alkalinity, sludge could be used to control pH in the optimal range for biohydrogen production avoiding drops that can bring to the failure of the process when using only FW (Jung et al., 2011; Zhu et al., 2011).

In this study, the production of methane and hydrogen of food waste (FW) and wastewater sludge (WS) were experimentally determined in order to compare possible upgrading solutions for a WWTP in Tuscany. Two possible layouts of FW and WS co-digestion were compared with the current WWTP (reference scenario). In these two co-digestion scenarios, the possibility to produce hydrogen by adding a new digester to perform dark-fermentation was evaluated. For each scenario, the mass balance, the energy budget and the greenhouse gas account were estimated.

The data used in the inventory were collected from several sources. The production of methane and hydrogen were determined by performing Biochemical Methane Potential (BMP) and Biochemical Hydrogen Potential (BHP) assays, that are well recognized among the scientific community as valuable, simple and low cost tools to assess the potential, adequacy and viability of the fermentative and methanogenic process (Cappai et al., 2014; Holliger et al., 2016; Labatut et al., 2011; Pecorini et al., 2016). The experimental data will be used as preliminary results to develop the two-phase co-digestion process in pilot and pre-industrial scale. Other data were obtained by direct management data of the WWTP, calculations and estimates.

## **2. Materials and methods**

### *2.1. Food waste and wastewater sludge characterization*

The WS and the FW used in the BMP and BHP assays were sampled at two treatment facilities in Tuscany. The WS was collected from the aerobic unit of the municipal wastewater treatment plant of Viareggio (LU, Italy) while the FW were sampled from the Organic Fraction of Municipal Solid Waste (OFMSW) delivered to a mechanical-biological treatment facility in the province of Florence. In particular, to obtain the FW samples, approximately 10 tons OFMSW were investigated by means of a picking analysis

(Laegerkvist et al., 2011). This sample was manually sorted in the following fractions: FW (45.8% w/w), garden waste (44.7% w/w), textiles (0.5% w/w), paper and cardboard (2.2% w/w), metals (0.1% w/w), wood (1.1% w/w), plastics (1.7% w/w), glass (1.2% w/w) and other (2.6% w/w). The sorted FW was then used for biohydrogen and biomethane production owing to its recognized potential (Holliger et al., 2016; Xiao et al., 2013). In order to homogenize the sample and to make it suitable for a wet fermentation technology, FW was grinded by blender and diluted with tap water until it reached a total solids (TS) content of approximately 15% w/w. In both BMP and BHP tests, sludge from an anaerobic reactor treating OFMSW was used as inoculum.

FW, WS and the inoculum were characterized through physical, chemical and bromatological analyses (Table 1). TS, Total Volatile Solids (TVS) and pH were determined according to standard methods (APHA, 2006). According to Angelidaki et al. cited by Holliger et al. (2016), TS determination was performed at 90°C instead of 105°C until constant weight in order to avoid the volatilization of volatile fatty acids. Proteins, lipids, cellulose, Total Kjeldhal Nitrogen contents were measured in accordance with the European Commission (2009). Carbohydrates were then calculated by subtracting to the total amount, the contents of humidity, ashes, proteins, lipids and fibers. Lignin was measured according to (MP 0424, 2010). Concerning the elementary composition C, H, N were obtained following (EN 15407, 2011) while S and P were measured using (EPA 6010 D, 2014) and (EN 13657, 2004) respectively. The oxygen content was estimated by subtracting the sum of C, H, N, S and P from the total. Ammonia was measured according to (APHA, 2012) while Total Organic Carbon (TOC) was measured thanks to (Ministero dell'Agricoltura e delle Foreste, 1989). Volatile Fatty Acids (VFAs: acetic and propionic acids) were measured according to (MP 0224 2012).

## *2.2. Hydrogen and methane production tests*

### *2.2.1. Biochemical Hydrogen Potential (BHP) tests*

The production of hydrogen from FW and SW was experimentally determined by performing biochemical hydrogen potential (BHP) assays. The analyses were conducted based upon the method described by Alibardi and Cossu (2015). The test was performed in triplicate using 1 L stainless steel batch reactors (Pecorini et al., 2016). The vessels were incubated in a water bath at 37°C for 7 days. After set-up the bottles were flushed with N<sub>2</sub> for few minutes to ensure anaerobic conditions in the headspace of the batches. The bottles were daily shaken to guarantee homogeneous conditions in the assay vessels. Each vessel was loaded with a Food/Microorganism ratio of 1/4 (w/w). The working volume of the bottle was approximately 0.5-l and consisted of inoculum, substrate, MES (2-N-Morpholino-EthaneSulfonic acid, VWR, Italy) buffer solution and HCl 2.5M to set initial pH at a value of 5.5. After set-up, the vessels were flushed with N<sub>2</sub> for few minutes to ensure anaerobic conditions. The inoculum, was previously heat-treated at 80°C for 30 minutes with the aim to select only hydrogen producing bacteria and inhibit hydrogenotrophic methanogens (Alibardi and Cossu, 2015; Cappai et al., 2014; Li and Fang, 2007). Biogas production was daily estimated by measuring the pressure in the headspace of each reactor and then converting to volume by the application of the ideal gas law. Pressure was measured using a membrane pressure gauge (Model HD2304.0, Delta Ohm S.r.L., Italy). The measured values of pressure were converted into biogas volume by Eq. (1).

$$V_{biogas} = \frac{P_{measured} T_{NTP}}{P_{NTP} T_r} V_r \quad (1)$$

where:  $V_{biogas}$  - volume of daily biogas production, expressed in Normal liter (NL);  $P_{measured}$  -

headspace pressure before the gas sampling (atm);  $T_r$  and  $V_r$  - temperature (K) and volume (L) of the reactor's headspace;  $T_{NTP}$  and  $P_{NTP}$  - normal temperature and pressure (273.15 K and 1 atm respectively).

**Table 1.** Food waste (FW), wastewater sludge (WS) and inoculum characterization

	<i>FW</i>	<i>WS</i>	<i>Inoculum</i>
TS (% w/w)	17.5 ± 0.8	1.9 ± 0.0	2.7 ± 0.1
TVS/TS (% w/w)	73.0 ± 1.5	79.9 ± 0.5	48.7 ± 0.5
pH	4.0 ± 0.2	4.4 ± 0.0	7.4 ± 0.3
TKN (%N w/w)	5.4 ± 0.4	0.2 ± 0.0	0.2 ± 0.0
TOC (%C w/w)	10.6 ± 1.9	1.2 ± 0.2	1.3 ± 0.2
Ammonia (mgN/kg)	856 ± 72	341 ± 47	1,040 ± 82
Acetic acid (mg/L)	5,200 ± 1,050	830 ± 120	< 40
Propionic acid (mg/L)	85 ± 26	390 ± 71	< 40
C (% TS)	53.8 ± 4.0	58.9 ± 4.3	50.8 ± 3.7
H (% TS)	5.7 ± 0.5	6.4 ± 0.5	3.9 ± 0.3
N (% TS)	3.4 ± 0.5	7.5 ± 0.8	8.0 ± 0.9
S (% TS)	0.2 ± 0.0	0.2 ± 0.0	0.2 ± 0.0
P (% TS)	0.6 ± 0.1	0.4 ± 0.1	0.4 ± 0.1
O (% TS)	36.3	26.6	36.7
Proteins (% w/w)	3.8 ± 0.2	0.9 ± 0.1	1.2 ± 0.1
Lipids (% w/w)	2.2 ± 0.2	< 0.3	< 0.3
Carbohydrates (% w/w)	6.9	0.1	0.1
Cellulose (% w/w)	3.5 ± 0.4	0.3 ± 0.3	0.4 ± 0.3
Lignin (% w/w)	1.3 ± 0.2	0.3 ± 0.0	0.3 ± 0.0

The BHP was determined as the cumulated hydrogen production divided by the TVS content contained in each batch. In order to determine the hydrogen production, the hydrogen content of the gas was measured by using gas chromatography (3000 Micro GC, INFICON, Switzerland).

### 2.2.2 Biochemical Methane Potential (BMP) tests

Biochemical Methane Potential (BMP) assays were performed for 21 days in order to determine the methane production of FW and WS. The analysis were conducted in triplicate based upon previous researches (Pecorini et al, 2016) and following the basic guidelines and advices included in Holliger et al. (2016). Each reactor was loaded with different amounts of substrate to achieve a concentration of substrate of about 2 gTVS/100 mL solution in each batch. This concentration is a compromise of, one hand, the need to use a large sample to have a good representativeness and to get a high easy-to-measure gas production, and, on the other hand, to avoid too large and impractical volumes of reactors and gas production and keep the solution dilute to avoid inhibition from accumulation of VFA and ammonia (Hansen et al., 2004). The inoculum to sample ratio was about 1.5:1 TVS basis and kept under 10:1 weight basis according to Pecorini et al. (2016) for fresh feed-in substrate (the amount of inoculum should be enough to prevent the accumulation of VFA and acid conditions). To determine the background methane production a blank assay with only the inoculum was done in triplicate. The inoculum was degassed for 5 days in order to deplete the residual biodegradable organic matter until the achievement of an endogenous metabolism phase. The test was performed at mesophilic conditions using the same equipment previously presented for BHP tests.

2.3. Co-digestion scenarios, inventory analysis

Two possible layouts of FW and WS co-digestion were compared with the current WWTP (reference scenario). In these two co-digestion scenarios, with reference to Fig. 1, Scenario H<sub>2</sub> (1) and Scenario H<sub>2</sub> (2), was evaluated the possibility to produce hydrogen by adding a new digester for the dark-fermentation to the current plant. For each scenario the mass balance, the energy budget and the greenhouse gas account were estimated. Beside the experimental data that will be presented in the next paragraph, the data reported in Table 2 were assumed in the inventory analysis.

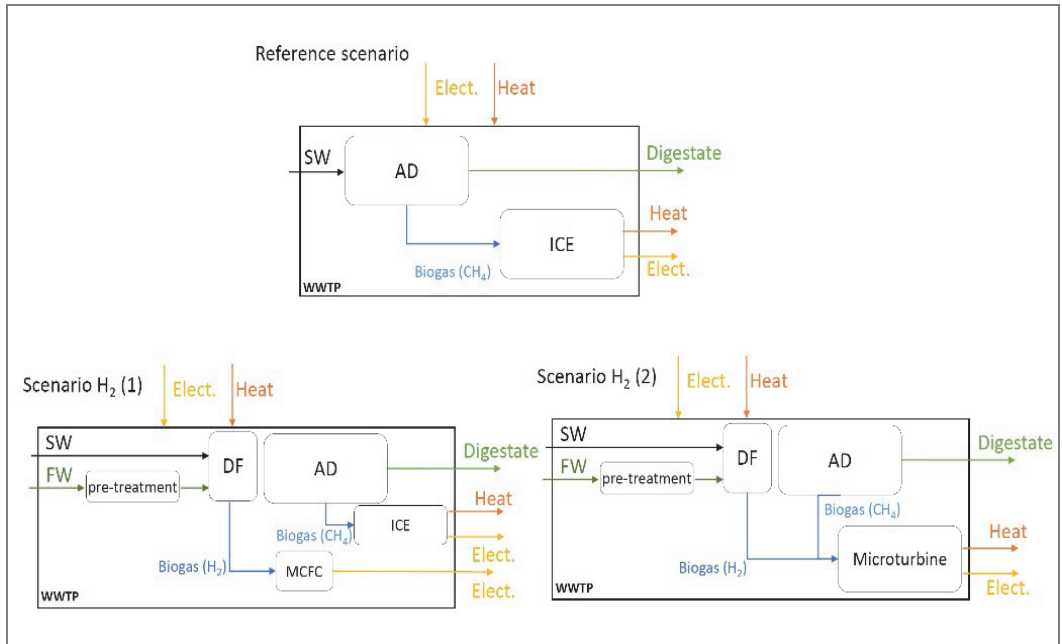

Fig. 1. Co-digestion scenarios layout

Table 2. Mass balance data inventory

	<i>Reference Scenario</i>	<i>Scenario H<sub>2</sub> (1)</i>	<i>Scenario H<sub>2</sub> (2)</i>
FW in (t/d)	0	54	54
TS (%)	-	28	28
TVS/TS (%)	-	73	73
WS in (t/d)	160	214	214
TS (% w/w)	0.7	0.7	0.7
TVS (% w/dw)	70	70	70
Digester volume	4500	818 (H <sub>2</sub> ) 4500 (CH <sub>4</sub> )	818 (H <sub>2</sub> ) 4500 (CH <sub>4</sub> )
SRT (d)	28	3 (H <sub>2</sub> ) 17 (CH <sub>4</sub> )	3 (H <sub>2</sub> ) 17 (CH <sub>4</sub> )
OLR (kgTVS/m <sup>3</sup> d)	0.17	14.7 (H <sub>2</sub> ) 2.3 (CH <sub>4</sub> )	14.7 (H <sub>2</sub> ) 2.3 (CH <sub>4</sub> )

Table 3 reports the main inventory data concerning energy flows. In particular, the electricity consumptions of the reference scenario were provided by the owner of the WWTP



while, for the co-digestion scenario the use of a screw-press to pre-treat the OFMSW prior to AD was considered. In all the scenarios, thermal energy consumptions were calculated accounting the heat needed to warm the digesters (working at mesophilic conditions) and the heat losses. Concerning the energy production, different choices were done. In the reference scenario it was consider to recover the biogas produced by an ICE. The use of a micro turbine was considered in scenario H<sub>2</sub> (2) in which, beside CH<sub>4</sub>, also the H<sub>2</sub> is produced. In scenario H<sub>2</sub> (1) the ICE that recover biogas from AD was integrated by a MCFC for electricity production by the H<sub>2</sub> from DF.

**Table 3.** Energy data inventory

	<i>Reference Scenario</i>	<i>Scenario H<sub>2</sub> (1)</i>	<i>Scenario H<sub>2</sub>(2)</i>
Electricity consumption (MWh/y)	730	1824	2145
Heat consumption (MWh/y)	1959	3755	3755
Bio-fuel utilization	ICE μ <sub>el</sub> = 0.391 μ <sub>t</sub> = 0.445 Functioning = 7500 h/y	MCFC (H <sub>2</sub> ) μ <sub>el</sub> = 0.45 Functioning = 7000 h/y ICE (CH <sub>4</sub> ) μ <sub>el</sub> = 0.391 μ <sub>t</sub> = 0.445 Functioning = 7500 h/y	Micro turbine μ <sub>el</sub> = 0.33 Exhaust gas flow = 4 kg/s Exhaust gas temp.=280°C Functioning = 8000 h/y

### 3. Results and discussion

#### 3.1. Hydrogen and methane productions

BMP results for FW were in agreement with previous researches. In particular, the review work of Campuzano and González-Martínez (2016) highlighted an average value for methane production of 415 ± 138 NL CH<sub>4</sub>/kgTVS<sub>sub</sub>. as biogas production was found lower than FW due to its lower content of readily biodegradable component such as carbohydrates (Alibardi and Cossu, 2016). Concerning hydrogen production, the average value of 55.0 NL H<sub>2</sub>/kgTVS<sub>sub</sub> is in the range of 25-85 NL H<sub>2</sub>/kgTVS<sub>sub</sub> found by Alibardi and Cossu (2015) for FW mixtures. Table 4 reports BMP and BHP tests outcomes in terms of averages and standard deviations.

**Table 4.** BMP and BHP tests results. Values are expressed as averages and standard deviations

	<i>FW</i>	<i>WS</i>
BMP (NLCH <sub>4</sub> /kgTVS <sub>sub</sub> , %CH <sub>4</sub> )	440.5 ± 8.7, 65.0 ± 2.3	159.3 ± 11.3, 55.0 ± 1.9
BHP (NLH <sub>2</sub> /kgTVS <sub>sub</sub> , %H <sub>2</sub> )	55.0 ± 3.6, 45.0 ± 2.4	0.1 ± 0.0, 0.30 ± 0.02

#### 3.2. Co-digestion scenarios performance

Table 5 shows the results of the mass balance, energy budget and greenhouse gas account estimated for each scenarios. In Fig. 2 the scenarios are compared in terms of energy and environmental performance. In order to assess the benefit gained with co-digestion in terms of energy savings, the net primary energy was calculated according to Eq. (2) (Pecorini et al., 2017), where:  $E_{el}$  is the net electricity produced in each scenario;  $Q_{th}$  is the net thermal

energy recovered in each scenario;  $\eta_{el,rif}$  is the reference efficiency for electricity, assumed equal to 0.525;  $p_g$  is the coefficient of distribution losses, assumed equal to 0.936,  $\eta_{th,rif}$  is the reference efficiency for thermal energy, assumed equal to 0.90.

$$Primary\ Energy = \frac{E_{el}}{\eta_{el,rif} \cdot P_g} + \frac{Q_{th}}{\eta_{th,rif} \cdot P_g} \quad (2)$$

Concerning the calculation of CO<sub>2</sub> equivalent saved the conversion factor of 0.551 kgCO<sub>2</sub>/kWh<sub>el</sub>.

**Table 5.** Co-digestion scenarios mass balance, energy budget and GHG emissions comparison

	<i>Reference Scenario</i>	<i>Scenario H<sub>2</sub> (1)</i>	<i>Scenario H<sub>2</sub> (2)</i>
<b>Biofuel produced</b>			
Biogas (Nm <sup>3</sup> /y)	82,000	535,619 (H <sub>2</sub> ) 2,662,206 (CH <sub>4</sub> )	535,619 (H <sub>2</sub> ) 2,662,206 (CH <sub>4</sub> )
CH <sub>4</sub> (Nm <sup>3</sup> /y)	53,827	1,730,434	1,730,434
H <sub>2</sub> (Nm <sup>3</sup> /y)	-	241,028	241,028
<b>Heat (MWh/y)</b>			
In	1,959	3,755	3,755
Out	219	7,049	6,716
Net	-1,740	3,295	2,962
<b>Electricity (MWh/y)</b>			
In	730	1,824	2,145
Out	193	6,501	5,833
Net	-537	4,677	3,689
<b>GHG emissions (t CO<sub>2</sub>eq)</b>			
Produced	163	5,226	5,226
Saved	296	-2,577	-2,032
Net	459	2,649	3,194

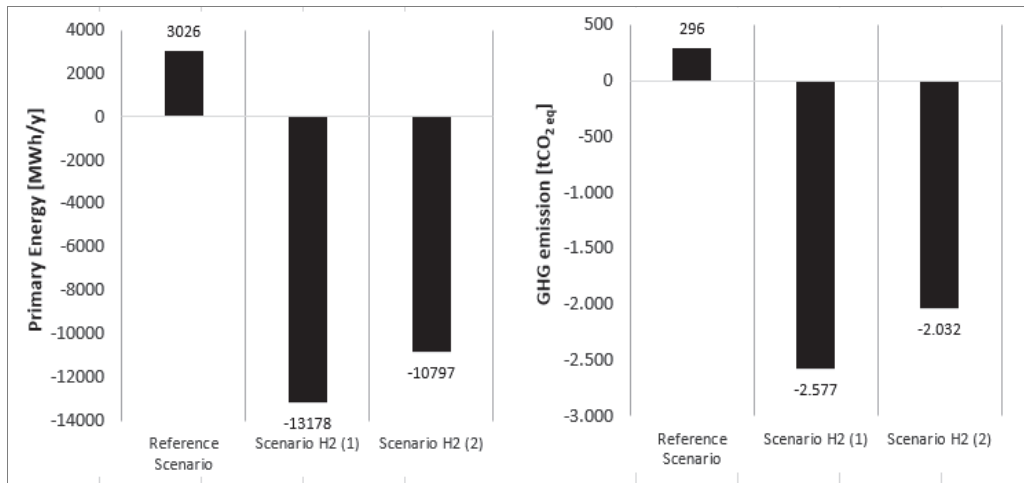

**Fig. 2.** Comparison of the performance of co-digestion scenarios

## 4. Conclusions

The results demonstrated that dark-fermentation, performed in a dedicated reactor prior to co-digestion, increases the treatment capacity and the biofuel production (both in terms of hydrogen and methane).

In all the scenarios, the savings achieved by energy recovery from biogas produced were estimated by comparing the use of an ICE, a microturbine and an ICE integrated by a MCFC. The assessment shows that the scenario in which fuel cells and ICE were considered for energy production is the most virtuous in terms of both primary energy saved and avoided emissions of carbon dioxide.

## Acknowledgements

This project has been funded with support from the MIUR-MISE-Regione Toscana DGRT 758/2013 PAR FAS 2007-2013. The authors want to thank the support of SEA Risorse and Alia S.p.A. for providing the waste samples.

## References

- Alibardi L., Cossu R., (2015), Composition variability of the organic fraction of municipal solid waste and effects on hydrogen and methane production potentials, *Waste Management*, **36**, 147-155.
- Alibardi L., Cossu R., (2016), Effects of carbohydrate, protein and lipid content of organic waste on hydrogen production and fermentation products, *Waste Management*, **47**, 69-77.
- APHA, (2006), Standard Methods for the Examination of Water and Wastewater, On line at: [https://www.mwa.co.th/download/file\\_upload/SMWW\\_1000-3000.pdf](https://www.mwa.co.th/download/file_upload/SMWW_1000-3000.pdf).
- APHA, (2012), APHA 4500 NH<sub>3</sub> B/C – Ammonia-Selective Electrode Method, On line at: [https://beta-static.fishersci.com/content/dam/fishersci/en\\_US/documents/programs/scientific/technical-documents/white-papers/apha-ammonia-ise-white-paper.pdf](https://beta-static.fishersci.com/content/dam/fishersci/en_US/documents/programs/scientific/technical-documents/white-papers/apha-ammonia-ise-white-paper.pdf).
- Campuzano R., González-Martínez S., (2016), Characteristics of the organic fraction of municipal solid waste and methane production: A review, *Waste Management*; **54**, 3-12.
- Cappai G., De Gioannis G., Friargiu M., Massi E., Muntoni A., Poletti A., Pomi R., Spiga D., (2014), An experimental study on fermentative H<sub>2</sub> production from food waste as affected by pH, *Waste Management*, **34**, 1510-1519.
- Cavinato C., Bolzonella D., Pavan P., Fatone F., Cecchi F., (2013), Mesophilic and thermophilic anaerobic co-digestion of waste activated sludge and source sorted biowaste in pilot- and full-scale reactors, *Renewable Energy*, **55**, 260–265.
- Cavinato C., Da Ros C., Pavan P., Cecchi F., Bolzonella D., (2014), Treatment of waste activated sludge together with agro-waste by anaerobic digestion: focus on effluent quality, *Water Science Technology*, **69**, 525–531.
- Da Ros C, Cavinato C, Pavan P, Bolzonella D., (2014), Winery waste recycling through anaerobic co-digestion with waste activated sludge, *Waste Management*; **34**, 2028–2035.
- EN 13657 (2004), EN 13657:2004 Characterization of waste – Digestion for subsequent determination of aqua regia soluble portion of elements, On line at: <http://ecommerce.sist.si/catalog/project.aspx?id=2db12457-71cd-4f00-b9bb-8eec93845c43>.
- EN 15407 (2011), EN 15407:2011 Solid recovered fuels – Methods for the determination of carbon (C), hydrogen (H) and nitrogen (N) content, On line at: <https://shop.bsigroup.com/ProductDetail/?pid=00000000030142938>.
- EPA 6010 D (2014), Inductively coupled plasma – optical emission spectrometry, On line at: [https://www.unil.ch/idyst/files/live/sites/idyst/files/shared/Labos/Hou%26Jones\\_2000.pdf](https://www.unil.ch/idyst/files/live/sites/idyst/files/shared/Labos/Hou%26Jones_2000.pdf).
- European Commission, (2009). European Commission Regulation 2009/152/EC of 27 January 2009 laying down the methods of sampling and analysis for the official control of feed, *Official Journal of the European Union*, 1–54.
- European Commission, (2017), Environment Directorate-general. LIFE and the Circular Economy. On line at: [http://www.ecsite.eu/sites/default/files/life\\_and\\_circular\\_economy\\_0.pdf](http://www.ecsite.eu/sites/default/files/life_and_circular_economy_0.pdf).

- Ghimire A., Frunzo L., Pirozzi F., Tralby E., Escudie R., Lens P.N.L., (2015), A review on dark fermentative biohydrogen production from organic biomass: process parameters and use of by-products, *Applied Energy*, **144**, 73-95.
- Hansen T.L., Jansen J.C., Davidsson A., Christensen T.H., (2004), Effects of pretreatment technologies on quantity and quality of source-sorted municipal organic waste for biogas recovery, *Waste Management*, **27**, 398-405.
- Holliger C., Alves M., Andrade D., Angelidaki I., Astals S., Baier U., Bougrier C., Buffière P., Carballa M., De Wilde V., Ebertseder F., Fernandez B., Ficara E., Fotidis I., Frigon J.C., Fruteau de Lacroix H., Ghasimi D.S.M., Hack G., Hartel M., Heerenklage J., Horvath I.S., Jenicek P., Koch K., Krautwald J., Lizasoain J., Li J., Mosberger L., Nistor M., Oechsner H., Oliveira J.V., Paterson M., Pauss A., Pommier S., Porqueddu I., Raposo F., Ribeiro T., Pfund F.R., Stromberg S., Torrijos M., Van Eekert M., Van Lier J., Wedwitschka H., Wierinck I., (2016), Towards a standardisation of biomethane potential tests, *Water Science and Technology*, **74**, 2515-2522.
- Iacovidou E., Ohandja D.G., Voulvoulis N., (2012), Food waste co-digestion with sewage sludge – Realising its potential in the UK, *Journal of Environment Management*, **112**, 267-274.
- Jung K.W., Kim D.H., Kim S.H., Shin H.S., Bioreactor design for continuous dark fermentative hydrogen production, *Bioresource Technology*, **102**, 8612-8620.
- Labatut R.A., Angenent L.T., Scott N.R., (2011), Biochemical methane potential and biodegradability of complex organic substrates, *Bioresource Technology*, **102**, 2255-2264.
- Laegerkvist A, Ecke H, Christensen TH., (2011), Waste Characterization: Approaches and Methods. *Solid Waste Technology & Management*, vol. 1, John Wiley & Sons Ltd, Chichester, UK.
- Li C., Fang H.H.P., (2007), Fermentative hydrogen production from wastewater and solid wastes by mixed cultures, *Critical Reviews in Environmental Science and Technology*, **37**, 31-39.
- Ministero dell'Agricoltura e delle Foreste, (1989), Decreto Ministeriale 19 luglio 1989 n.196 – Metodi ufficiali di analisi per i fertilizzanti Supplemento n.1., Rome, Itali.
- MP 0224, (2012), MP 0224 rev 2 2012 – *Volatile Fatty Acids*, On line at: <http://pa.sinal.it/PA59AR83.PDF>
- MP 0424, (2010), MP 0424 rev 5 2010 – *Lignin*, On line at: <http://pa.sinal.it/PA59AR83.PDF>.
- Nghiem L.D., Koch K., Bolzonella D., Drewes J.E., (2017), Full scale co-digestion of wastewater sludge and food waste: bottlenecks and possibilities, *Renewable and sustainable Energy Reviews*, **72**, 354-362.
- Pecorini I., Baldi F., Carnevale E.A., Corti A., (2016), Biochemical methane potential tests of different autoclaved and microwaved lignocellulosic organic fractions of municipal solid waste, *Waste Management*, **56**, 143-150.
- Pecorini I., Bacchi D., Albini E., Baldi F., Galoppi G., Rossi P., Paoli P., Ferrari L., Carnevale E.A., Peruzzini, M., Lombardi, L., Ferrara, G., (2017), *The Bio2Energy Project: Bioenergy, Biofuels and Bioproducts from Municipal Solid Waste and Sludge*, Proc. of the 25th Edition European Biomass Conference & Exhibition, 12-15 June 2017 Stockholm, Sweden.
- Xiao L., Deng Z., Fung K.Y., Ng K.M., (2013), Biohydrogen generation from anaerobic digestion of food waste, *International Journal of Hydrogen Energy*, **38**, 13907-13913.
- Zhu H., Parker W., Conidi D., Basnar R., Seto P., (2011), Eliminating methanogenic activity in hydrogen reactor to improve biogas production in a two-stage anaerobic digestion process co-digesting municipal food waste and sewage sludge, *Bioresource Technology*, **102**, 7086-7792.



Procedia Environmental Science, Engineering and Management 4 (2017) (4) 173-181

21st International Trade Fair of Material & Energy Recovery and Sustainable Development,  
ECOMONDO, 7th-10th November 2017, Rimini, Italy

---

## **BIOFILTRATION PROTOTYPES FOR METHANE OXIDATION IN LANDFILL AFTERCARE AND ABATEMENT OF NMVOCs AND ODOROUS COMPOUNDS\***

**Isabella Pecorini<sup>1\*\*</sup>, Donata Bacchi<sup>1</sup>, Giovanni Ferrara<sup>1</sup>, Elena Rossi<sup>1</sup>,  
Renata Laura Caselli<sup>2</sup>, Luca Zipoli<sup>3</sup>, Fabio Menghetti<sup>4</sup>,**

<sup>1</sup>*"DIEF, Department of Industrial Engineering, University of Florence,  
Via di Santa Marta 3, Florence 50139, Italy*

<sup>2</sup>*Settore Rifiuti e Bonifica dei Siti Inquinati, Regione Toscana,  
Piazza dell'Unità Italiana 1, 50123 Firenze, Italy Firenze*

<sup>3</sup> *Centro Servizi Ambiente Impianti S.p.A., S.P. 7 via di Piantravigne, 52028 Terranuova Bracciolini  
(AR), Italy*

<sup>4</sup> *Siena Ambiente S.p.A., via Simone Martini 57, 53100 Siena, Italy*

---

### **Abstract**

Landfills are listed as the second anthropogenic source of atmospheric methane (CH<sub>4</sub>) contributing significantly to climate change. In addition, landfill gas (LFG) may contain more than 200 non-methane volatile organic compounds (NMVOCs) that may be toxic, odorous or both. Biofilter and biocovers have been identified as an alternative and cost-effective technology to control and mitigate impacts due to CH<sub>4</sub> and NMVOCs emissions in both managed and unmanaged landfills. Two biofiltrations prototype were designed and constructed: an active biofiltration system (biofilter) at Podere il Pero landfill (Arezzo, Italy) and a passive biofiltration system (biowindow) at Le Fornaci landfill (Siena, Italy). The biofiltration systems are monitored to study the biological process and evaluate the methane oxidation efficiency and the attenuation of NMVOC emissions. The results of the monitoring campaigns showed that the active biofiltration system has a relatively high capacity for the CH<sub>4</sub> methane oxidation (60-70%) while the passive biofiltration systems showed CH<sub>4</sub> oxidation efficiency up to 100%. The results of the monitoring NMVOCs showed a significant reduction (76.98% for the biofilter) of the pollutant inlet the biofiltration prototypes. The odorous emissions results always under the value indicated as concentration limit normally prescribed for exhaust air treatment devices.

*Keywords:* biofiltration, methane oxidation, NMVOCs, odorous emissions

---

\*Selection and peer-review under responsibility of the ECOMONDO

\*\* Corresponding author: e-mail: [isabella.pecorini@unifi.it](mailto:isabella.pecorini@unifi.it);

## **1. Introduction**

One of the main environmental challenges associated with landfills is the generation of LFG, produced by the anaerobic decomposition of the organic waste fraction. LFG is mainly composed by CH<sub>4</sub> and carbon dioxide (CO<sub>2</sub>), and its production lasts until most of the organic material in waste is degraded, which can take several decades. Apart from the CH<sub>4</sub> and CO<sub>2</sub>, in the LFG can be found NMVOCs, including aliphatic (alkanes, alkenes), aromatic (benzene, toluene, ethylbenzene etc.), halogenated (dichlorodifluoromethane, vinyl chloride etc.) hydrocarbons and alcohols (ethanol, methanol etc.). Moreover, many of these are highly odorous, for example the sulphur containing mercaptans and dimethyl sulphides (EPA, 2010). Hydrogen sulphide, also generated within the waste and highly odorous is present, but is not classified as a NMVOCs. NMVOCs are produced during anaerobic biological decomposition of the organic matter in wastes and due to the volatilization of solid waste components exists in wastes (Liu et al., 2015). A smaller amount may arrive into landfills from waste materials such as paints, glues adhesives or solvents that are consigned to landfill (EPA, 2010) Although these trace NMVOCs account for less than 1% of the total emissions, their adverse effects on environment should not be overlooked (Zou et al., 2003), because of the potential toxicological importance of some components (benzene, chloroethane, chloroethene, 2-butoxy ethanol, arsenic, mercury, methanal, 1,3-butadiene etc.) (Parker et al., 2002). The surface emissions of NMVOCs occurs mainly because LFG acts as a carrier gas and flushes the trace gases out of the landfill body to the atmosphere (EPA, 2010).

The reduction of LFG emissions is a central issue of the EU Landfill Directive (Directive 99/31/EC). In order to reduce the CH<sub>4</sub> emissions from the waste management sector the Directive acts through two main measures: (i) the mandatory use of LFG extraction and energy recovery systems or LFG flaring in all new disposal sites; (ii) the progressive reduction of the amount of biodegradable waste going to landfill. However, some critical issues regarding the management of LFG with low calorific value are still present. In fact, when the CH<sub>4</sub> concentration is too low for combustion (<30%v/v) the gas collected is vented without thermal treatment.

This study is part of the LIFE RE Mida project that aims to provide direct environmental benefits by the mitigation of uncontrolled LFG and NMVOCs emissions from old and unmanaged landfills throughout the implementation of two demonstrative biofiltration systems full-scale. The two biofiltration systems, described in the section below, are located in two aftercare landfills. This paper presents the results of the monitoring campaign made in order to assess the performance in terms CH<sub>4</sub> oxidation efficiency and the attenuation of NMVOCs emissions. Moreover, are described the methodologies applied to evaluate the oxidation capacity and attenuation of NMVOCs.

## **2. Site characterization**

In these section is provided a description of the landfills and of the prototypes implemented in the project. Podere il Pero landfill is a landfill for non-hazardous waste located in the Province of Arezzo (Tuscany). The landfill is divided into four sections. The landfill was active from 1994 until March 2014. The final volume achieved is amount 631,000 m<sup>3</sup>. The operations of closure (installation of final capping) started in the summer 2015 and are currently ongoing. A total of approximately 660,000 tons of waste had been disposed at Podere il Pero. The dominating waste types are soil fill, household refuse and sludge from wastewater treatment plants. The LFG extraction system consists in 44 vertical wells and 8 leachate wells and a network of pipes connected to 6 points for suction control. Currently, a LFG flare is used for the thermal treatment.

The LFG produced in the landfill body is characterized by a flow rate of 128 Nm<sup>3</sup>/h and a CH<sub>4</sub> concentration in the range of 26.5-40%v/v. The current data, measured on continuous basis by the site manager (CSAI S.p.A, industrial partner of the project), shows a decrease of the LFG production and quality, so biofilter can be an alternative technology for the LFG treatment during the aftercare phase. Based on the outcomes of preliminary site characterization, the biofilter has been designed to treat a LFG flow ranging between 20 and 50 Nm<sup>3</sup>/h. An average LFG composition of 20% CH<sub>4</sub>, 35% CO<sub>2</sub>, 10% O<sub>2</sub> and 35% N<sub>2</sub> has been considered. The biofilter has a total area of 270 m<sup>2</sup>, 18x15 meters. The containment walls, made of concrete, are 2 m high. The biofilter is covered with a pitched roof to control leachate formation (Fig. 1b). A dedicated blower fed the biofilter with the LFG coming from the body of the landfill. A bottom distribution layer of coarse gravel (grain size 15-30 mm) of 40 cm height homogeneously distributes the LFG inside the biofilter. The filter media is 1.4 m high.

Le Fornaci di Monticiano Landfill is an old landfill of MSW in the Province of Siena. This plant closed before the entry in force of the Landfill Directive. The landfill consists in two sections: the older part was managed by the municipality of Monticiano, while the other part was managed by Sienambiente (SA, industrial partner of the project). The more recent section was active between the 1996 and the 2001. In this section, about 29,300 tons of waste had been disposed. The LFG is managed through a passive system (no extraction blower is present) that involves 15 vertical wells equipped with riser pipes surrounded by gravel pack. Each well supports little flares with manual ignition. The LFG generation over time has been estimated through a LFG model by considering the quantities and the composition of waste disposed in the landfill. The model shows negligible LFG generation from the landfill body at 2016. For these reasons, Le Fornaci di Monticiano was chosen as site in which develop the passive biofiltration systems. Throughout a field survey, using the static accumulation chamber, were analysed LFG emissive fluxes and detected the emissive hot-spots surrounding the LFG wells in which realize the passive biofiltration systems: 7 prototypes were built. Each biowindow has a volume of about 5 m<sup>3</sup> with a filtering section of 4 m<sup>2</sup> (2m x 2m). The biowindows consist of a gravel layer for the proper LFG distribution and an overlying the oxidizing layer, where CH<sub>4</sub> oxidation occurs. The thicknesses of the layers were approximately 120 cm (oxidizing bed), and 20 cm (gravel layer, grain size 15-30 mm), Fig. 1a. Metal formworks were used to contain the filtering bed and reinforce the whole module. The LFG migrates through the landfilled waste (below the landfill cover) to the biowindows due to pressure differences and diffusion (Gebert and Groengroeft, 2006). The biowindow media has a higher permeability compared to the landfill cover layer, and thus LFG moves through this towards the atmosphere. To limit rainwater entry, each biowindow has been protected with clay levees.



**Fig. 1.** Biofiltration systems: (a) biowindow, (b) biofilter



In both prototypes compost mixed to sand in a volume ratio of 5:1 as structural material (Jugnia et al., 2008) was used as oxidizing media; indeed, from previous literature review, compost has proved to be a suitable substrate for biocovers constructions (Huber-Humer et al., 2009; Mor et al., 2006; Scheutz et al., 2009). The compost used in the prototypes fulfilled most of the criteria indicated by the authors Huber-Humer et al. (2009) showing optimal characteristics in terms of physical, chemical and maturity properties.

### **3. Materials and methods**

A detailed review of the state-of-the-science regarding microbial CH<sub>4</sub> oxidation has been done to identify the appropriate methods and operations to control the factors affecting the biological process and the oxidation rate. Based on the results of the review was established the monitoring control plan.

Basically, the assessment of the performance of the biofiltration systems is done by measuring the gas concentrations profiles, the temperature of the bio-oxidizing bed at different depths and evaluating the surface emissions of CH<sub>4</sub> e CO<sub>2</sub>. Moreover, the climate conditions are of importance for the actual CH<sub>4</sub> oxidation rate. As such, ambient temperature, atmospheric pressure, air moisture and precipitation are continuously monitored thanks to the meteorological stations.

#### *3.1. Gas concentration profiles*

Gas concentration profiles are measured by placing multilevel probes (10, 20, 30, 40, 50, 60, 70, 80, 90, 100, 110 e 130 cm) below the surface level and drawing gas samples to be analysed for main landfill gas components: CH<sub>4</sub>, CO<sub>2</sub>, O<sub>2</sub> and H<sub>2</sub>S. The gas concentration probes are made of PVC pipes of 16 mm ID and closed at both ends. Each pipe, at the lower end, is provided of six 2 mm slots to drawing gas samples. The instrument used to measure pollutant concentrations (CH<sub>4</sub>, CO<sub>2</sub>, O<sub>2</sub> and H<sub>2</sub>S) is Ecoprobe 5 (IR analyser; Rs Dynamics). For each sampling probe, the integration time of the measure was determined based on the probe volume. For each passive biofiltration system (biowindows) the gas concentration profile is evaluated in duplicate while for the biofilter have been installed 6 sampling lines. Besides, is measured the temperature of the oxidizing bed at 10, 20, 30, 40, 50, 60, 70, 80, 90, 100, 110 cm with a penetration probe (Hanna Instruments, HI 935005).

#### *3.2. Surface flux measurements*

Surface emissions of CH<sub>4</sub> and CO<sub>2</sub> were determined using the static flux chamber method. According to the method, the measure of a surface flow of a pollutant is based on the increase of the concentration of the pollutant within the chamber. The emissive flow of a pollutant can be estimated by evaluating the  $\alpha$  derivative in the initial trajectory of the dependency function between the pollutant concentration in the chamber and the time within the system conditions (or control volume) are respected. The equipment used in the field is made up of a flux chamber and a gas analyser (Ecoprobe 5, IR analyser, Rs Dynamics). The flux chamber is made of HDPE with a thickness of 1 cm and was developed during PhD thesis by Pecorini (2010), it has a radius of 10 cm and a height of 10.5 cm. The upper base is enclosed with a 27 cm square plexiglas panel and a thickness of 1 cm, on which three valves are inserted, two of which are connected to PVC pipes of 0.6 cm diameter forming a closed loop between the flux chamber and the analyser, Fig. 1a. Inside the flux chamber is installed a fan to achieved a homogenization of the collected gas.

Instead, the dynamic flux chamber method is in accepted standard EPA sampling method to control NMVOC's emissions (NSCEP, 1995). According to this method, the chamber is located on the area that usually represent an emissive hot-spot. The chamber is

made of PTFE, with an inner diameter of 50 cm and an outside diameter of 20 cm, inside the chamber there is a multifare spiral gas distribution system, made of PTFE and a tubular shape windshield with diameter of 25 cm and height of 40 cm, Fig. 1b. The nitrogen flushing flow rate in the chamber was established at 4 m<sup>3</sup>/h (Fig. 2b).

The methodologies UNI EN 13725:2004, U.S. EPA TO 11A 1999, NIOSH 6013:1994 were applied to evaluate respectively the odorous emissions, the H<sub>2</sub>S concentration and the NMVOCs concentration. For the biofilter was decided to perform three surface sampling and to evaluate the NMVOCs and odorous compound also on the inlet biogas. Besides, were chosen 3 biowindows on which perform a surface and biogas sampling.

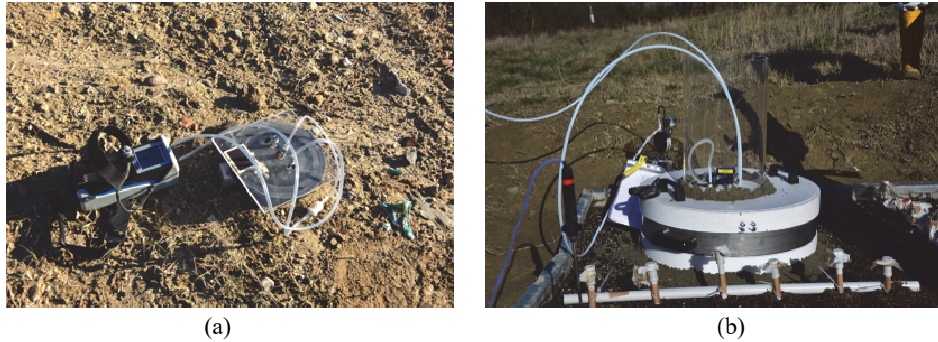

**Fig. 2.** Surface flux measurement: a) static flux chamber method b) dynamic flux chamber method

### 3.3. Evaluation of prototype performance

The methodology proposed by the authors Gebert et al. (2011) is used to assess the oxidation efficiency of the biofiltrations systems. The method proposed by the authors is based on the gas concentration profiles of CH<sub>4</sub> e CO<sub>2</sub> evaluated during the monitoring campaign throughout soil gas sampling. If the biomass respiration phenomena are negligible and the CO<sub>2</sub> concentration is mostly due to the CH<sub>4</sub> oxidation by methanotrophic bacteria the method can be applied. By dividing the share of oxidized CH<sub>4</sub> up to depth *i* by the concentration of CH<sub>4</sub> in the landfill gas (CH<sub>4</sub><sub>LFG</sub>). The oxidation efficiency is calculated using the Eq. (1):

$$Eff_{ox} = \frac{x}{CH_{4\_LFG}} \quad (1)$$

The attenuation efficiency of the NMVOCs of the active biofiltration system is calculated using a mass balance method, from the fluxes into and out the system, as follows (Eq. 2):

$$Eff_{NMVOCs} [\%] = \frac{flux_{NMVOCs\ in} - flux_{NMVOCs\ out}}{flux_{NMVOCs\ in}} \quad (2)$$

where  $flux_{NMVOCs\ in}$  (μg m<sup>2</sup> h<sup>-1</sup>) according to Liu et al. (2015) is the product of the inlet nitrogen flushing flow rate (m<sup>3</sup>/h) and the concentration of volatile compound in the sample (μg/m<sup>3</sup>), divided by the contact area of the chamber (m<sup>2</sup>).

#### 4. Results and discussion

This paper presents the results of the monitoring campaigns made in order to assess the CH<sub>4</sub> oxidizing capacity of both biofiltration systems and to evaluate the abatement efficiency of NMVOCs. At the moment have been carried out 9 complete monitoring campaigns, according to the timetable of the monitoring and control plan defined by the project (not show here). The first two campaigns were made to validate the routine monitoring protocol and assess the preliminary performance of both prototypes.

Concerning the biofilter, Fig. 3 illustrates the results of the average methane oxidation capacity of the prototype. For each monitoring campaign is resulted a significant oxidation efficiency, ranging from 35 to 75%. Thus, in accordance with the high temperatures measured in the biofilter bed (results not show) indicates the presence of active biological process. The inlet methane load has been kept constant in terms of both LFG flow (about 20 Nm<sup>3</sup>h<sup>-1</sup>) and CH<sub>4</sub> concentration (between 16 and 19% v/v) since the goal of the activities was to grow methanotrophs bacteria.

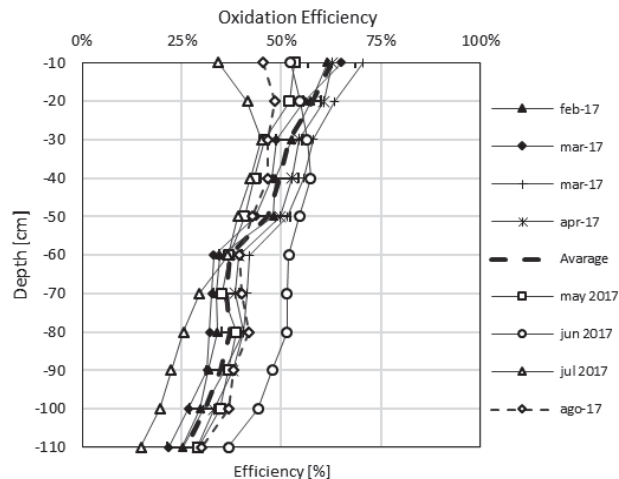

**Fig. 3.** Biofilter average oxidation efficiency

Fig. 4a illustrates the results of the fluxes of NMVOCs in the inlet biogas compared with the emission rate from the surface of the biofilter. Aliphatic hydrocarbon compounds (isobutane, n-butane, n-pentane, n-hexane, n-heptane and propylene), are the most NMVOCs present in the analysed samples. These compounds are produced by the biological degradation processes and are usually associated with older sections of the landfill (Parker et al., 2002). The oxygenated compounds were found at appreciable but not very high concentrations in the inlet biogas and it results in a high attenuation of these pollutants from the surface emissions. The concentrations of halogenated compounds in the inlet biogas result higher than those of oxygenated one and it results in a higher flux entering the biofilter. This is probably due to the composition of the waste in the landfill, in fact the emissions of halogenated compounds in landfill gas it seems to be governed by the composition of waste and are not affected by the biological degradation processes (Liu et al., 2015). Overall, the concentrations of sulfuric and terpene compounds are lower than those normally found in the landfill gas. There is a significant reduction of NMVOCs pollutants in the surface emissions, especially the concentration of halogenated and aromatic sulphur

compounds whose concentration is not appreciable in the gas emitted due to the limits of low detection that can be achieved with the methods used. In particular, the attenuation efficiency of hydrogen sulphide (H<sub>2</sub>S) is 99.97%.

The odor concentrations, of the gas emitted from the biofilter surface are quite low at all sampling points. The higher odour concentration detected was 166 [UO/Nm<sup>3</sup>], below 300 UO/Nm<sup>3</sup>, the concentration limit normally prescribed for exhaust air treatment devices (biofilters waste treatment plants).

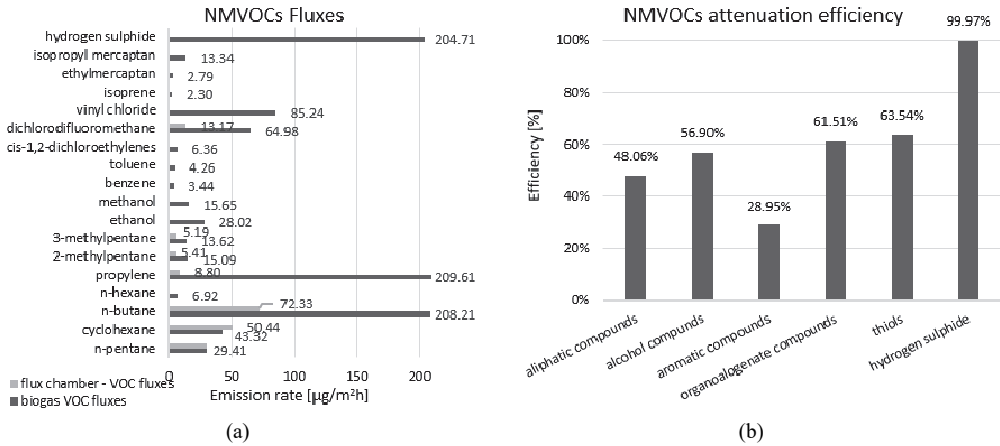

Fig. 4. Biofilter characterization of NMVOCs: a) comparison of NMVOCs fluxes in and out of the prototype b) biofilter NMVOCs attenuation efficiency

Concerning the passive biofiltration systems, Fig. 5 illustrates the methane oxidation efficiency capacity of the prototypes.

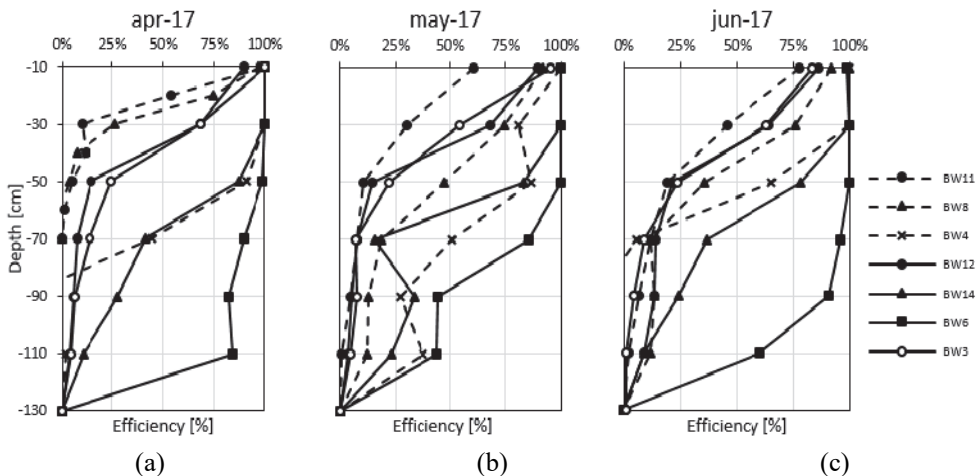

Fig. 5. Biowindows methane oxidation efficiency: a) April 2017, b) May 2017, c) June 2017

Depending on the inlet methane load (results not show here) were observed three main behaviours of the prototypes:

- biowindows 4 and 6 (CH<sub>4in</sub><10% v/v) show the higher oxidation efficiency (100%),
- biowindows 8 and 14 (CH<sub>4in</sub>=10-25% v/v) show an average oxidation efficiency,

ranging between 80-100%;

- biowindows 11, 12 and 3 ( $CH_4$  in > 25% v/v) show the lower oxidation efficiency (<75%).

This is mainly due to the fact that high concentrations of methane and low  $O_2$  concentrations may inhibit methanotrophic bacteria, while at a concentration of 30% v/v in the inlet biogas are detected the maximum oxidation rate (Scheutz et al., 2009).

As a result of the evaluation of surface emissions of  $CH_4$  and  $CO_2$  was decided to sample the most emissive biowindows (numbers 8, 11 and 12) to control NMVOCs and odorous compounds surface emissions. Concerning these prototypes, it is not possible to know the inlet flow of LFG in each device and for this reason Fig. 6. illustrates the NMVOCs concentration detected in the inlet LFG and in the surface gas samples of the devices number 11. Similar graphics were also obtained for the other 2 sampling points but are not reported here.

The oxygenated and halogenated compounds were detected at appreciable but not very high concentrations except the LFG entering the device 12. The concentrations of sulfuric and terpene compounds are lower than those normally found in the landfill gas. For device number 11 an inlet concentration of  $36.6 \text{ mg/Nm}^3$  of  $H_2S$  was found, negligible concentrations were detected for the other modules analyzed.

About the odorous emission were found very low concentrations: BW8  $18 \text{ UO/Nm}^3$ , 32  $\text{UO/Nm}^3$ , 23  $\text{UO/Nm}^3$ .

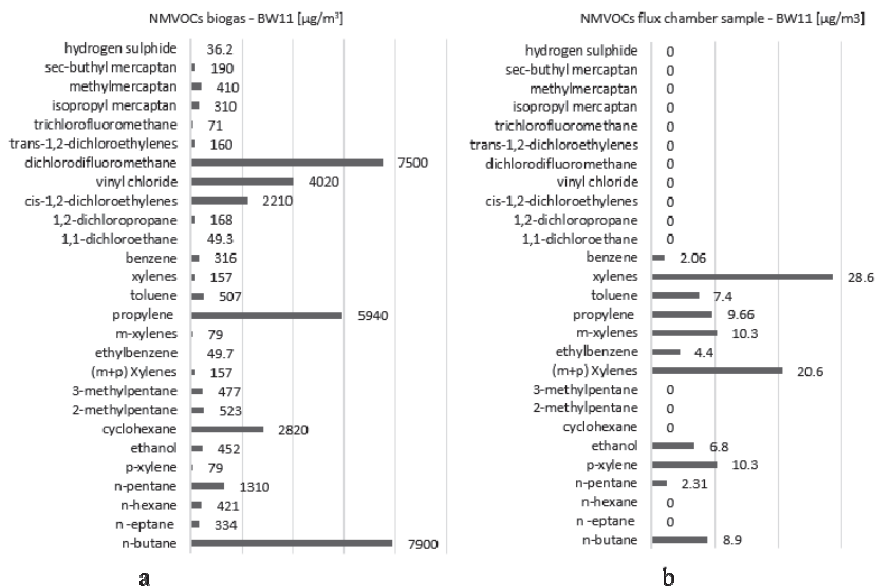

Fig. 6. Biowindows NMVOCs characterization: a) concentration of NMVOCs inlet the prototype and b) concentration of NMVOCs in the surface sample

## 5. Concluding remarks

The monitoring and control plan implemented is a viable approach to evaluate the performance and the  $CH_4$  oxidation efficiency of the prototypes installed at Podere il Pero e Le Fornaci landfills.

During the monitoring campaigns for both biofiltration systems was detected methanotrophic activity. In addition, during all the monitoring period was detected a methane oxidation capacity more than 50% for the biofilter and over 70% for the biowindows.

Also, a high efficiency of abatement of NMVOCs and even odorous compounds was observed.

### **Acknowledgements**

LIFE RE Mida project (LIFE 14 CCM/IT/000464) is co-funded by LIFE Climate Action - Climate Change Mitigation.

The authors want to thank the partners CSAI S.p.A and Sienambiente S.p.A for the technical support provided.

### **References**

- EPA, (2010), Office of Environmental Enforcement Surface VOC Emissions Monitoring on Landfill Facilities, Air Guidance Note 6 (AG6), On line at <https://www.epa.ie/pubs/advice/air/emissions/AG6.pdf>
- Gebert J., Groengroeft A., (2006), Passive landfill gas emission - Influence of atmospheric pressure and implications for the operation of methane-oxidising biofilters, *Waste Management*, **26**, 245-251.
- Gebert J., Rower I.U., Scharff H., Roncato D.L.C., Cabral A.R., (2011), Can soil gas profiles be used to assess microbial CH<sub>4</sub> oxidation in landfill covers? *Waste Management*, **31**, 987-994.
- Huber-Humer M., Roder S., Lechner P., (2009), Approaches to assess biocover performance on landfills. *Waste Management*, **29**, 2092–2104.
- Jugnia L.B., Cabral A.R., Greer C.W., (2008), Biotic methane oxidation within an instrumented experimental landfill cover, *Ecological Engineering*, **33**, 102-109.
- Liu Y., Lu W., Li D., Guo H., Caicedo L., Wang C., Xu S., Wang H., (2015), Estimation of volatile compounds emission rates from the working face of a large anaerobic landfill in China using a wind tunnel system, *Atmospheric Environment*, **111**, 213-221.
- Mor S., De Visscher A., Ravindra K., Dahiya R.P., Chandra A., Van Cleemput O., (2006), Induction of enhanced methane oxidation in compost: temperature and moisture response, *Waste Management*, **26**, 381–388.
- NSCEP, (1995), Determination of Landfill Gas Composition and Pollutant Emission Rates at Fresh Kills Landfill, vol. 1. Project Report. 272. EPA902-R-95-001a:4-56-4-61.
- Parker T., Dottridge J., Kelly S., (2002), Investigation of the composition and emissions of trace components in Landfill Gas, R&D Technical Report P1-438/TR, Environmental agency UK, On line at <http://gassim.co.uk/documents/P1-438-TR%20Composition%20of%20Trace%20Components%20in%20LFG.pdf>
- Pecorini I., (2010), Monitoring systems for the diffuse emissions of landfill biogas for the optimization of the management system (in Italian: Sistemi di monitoraggio delle emission diffuse di biogas da discarica per la ottimizzazione del Sistema di gestione), PhD Thesis, Università degli Studi di Firenze, Italy.
- Scheutz C., Kjeldsen P., Bogner J.E., De Visscher A., Gebert J., Hilger H.A., Huber- Humer M., Spokas K., 2009, Microbial methane oxidation processes and technologies for mitigation of landfill gas emissions, *Waste Management and Research*, **27**, 409–455.
- Zou S.C., Lee S.C., Chan C.Y., Ho K.F., Wang, X.M. Chan L.Y., Zhang Z.X., (2003), Characterization of ambient volatile organic compounds at a landfill site in Guangzhou, South China, *Chemosphere*, **51**, 1015-1022.



Procedia Environmental Science, Engineering and Management, 4 (2017) (3) 183-189

21th International Trade Fair of Material & Energy Recovery and Sustainable Development,  
ECOMONDO, 7th-10th November 2017, Rimini, Italy

---

## **COST AND BENEFIT ANALYSIS AS A TOOL TO SUPPORT DECISIONS ON ENERGETIC STREAMLINING IN THE GREEN BUILDING SECTOR\***

**Martina Sgandurra<sup>1\*\*</sup>, Giulia Salerno<sup>1</sup>, Alessia Passalacqua<sup>1</sup>,  
Cinzia Martelli<sup>2</sup>, Antonella Rinaldo<sup>2</sup>**

<sup>1</sup>*Department Economics and Business, University of Catania, Corso Italia 55- 95129 Catania, Italy*

<sup>2</sup>*Prefabbricati di Martelli Salvatore & C. s.a.s., Viale J. Kennedy,  
Zona Artigianale, lotto 125, 95034, Bronte (Catania), Italy*

---

### **Abstract**

The building sector has an important impact on society and on the environment. The different activities of the building sector, including design, construction, restoration and demolition, affect the environment. An environmentally sustainable building, designed and constructed to minimize environmental impact, is called a “green building”. Green buildings entail several economic advantages in terms of their running risks and costs. Among the benefits, it is possible to highlight: risk mitigation, greater comfort, higher levels of welfare, lower levels of emissions, increased environmental awareness. From the point of view of the cost and benefit analysis, the initial elevated extra costs of design and building decrease significantly over the years, if compared to the costs of a traditional building. The costs that can be reduced are related to energy and water consumption, maintenance and lower long-term operations. Moreover, buildings with better sustainability credentials have raised marketability, consequently this market niche will probably become prosperous, becoming an opportunity for energy saving. Wooden houses have won against several prejudices, showing extraordinary qualities, compatible with the future vision of sustainable building. The aim of this study is to analyze the business “Prefabbricati Martelli” in Sicily, which is becoming more and more important, because it prioritizes environmental and social sustainability, revolutionizing the concept of living and representing a relevant example of symbiosis between innovation and environment. Despite the artisanal quality of the products and the total energy costs, both those of purchase and use are lower than the industrial ones.

*Keywords:* energy saving, green building, sustainability, symbiosis, wooden house.

---

\*Selection and peer-review under responsibility of the ECOMONDO

\*\* Corresponding author Corresponding author: e-mail: [martisgandurra@gmail.com](mailto:martisgandurra@gmail.com)



## 1. Introduction

The building sector is considered capable of meeting new needs in terms of energy saving and climate changes. This can be shown by the percentage of energy consumption in the building sector related to many countries, such as the USA, Europe and Russia: 40% in 2008 ([www.dime-eu.org](http://www.dime-eu.org)) and 30% in 2016 ([www.iea.org](http://www.iea.org)). The demand for residential and commercial buildings and higher standards of living are rising, entailing a greater consumption of energy. Among energy-intensive activities, electricity for heating and cooling (Harvey, 2009) should be considered to make better decisions in terms of energy saving. Therefore, since the energetic impact of global urbanization is due to high levels of urban population (expected to grow from 47% of the total in 2000 to 70% in 2050) ([www.iea.org](http://www.iea.org)), the growth of single-person households should be encouraged.

In this specific case, the cost and benefit analysis is used as a method to support decisions on energetic streamlining in the green building sector. The term “cost” refers to the initial elevated extra costs of design and building and the total energy costs, considering those of purchase and use. On the other hand, the term “benefit” includes all the advantages that come from environmental sustainability in terms of green building: environmental risk mitigation, greater living comfort, anti-seismic regulations, higher levels of welfare, lower levels of CO<sub>2</sub> emissions, better quality of buildings and increased environmental awareness (Harvey, 2009).

The main aim of this case study is to analyze in terms of costs and benefits the wooden building structures, analyzing the Sicilian firm “Prefabbricati Martelli Salvatore & C.”, specialized in the production of wooden structures. Over the years, the firm’s core business has become the construction of wooden houses. This Sicilian firm builds wooden canopies, gazebos, projecting roofs, slabs, staircases, railings, parapets, floors, but also major infrastructures such as turrets and bridges. Thus, it is specialised in producing public and private structures as well as in offering consultation and design services ([www.struttureinlegnomartelli.it](http://www.struttureinlegnomartelli.it)) so as to guarantee comfortable wooden buildings, revolutionizing the concept of sustainable living. Wooden structures can be set in the global energy-efficient building market, which is expected to grow at a CAGR of 9.6% ([www.reportlinker.com](http://www.reportlinker.com)). This forecast is due to the fact that wooden buildings use energy, materials, water and land more efficiently than traditional buildings. Indeed, wood is a great thermal insulator and this allows a cool temperature to be kept during the summer and a warm one in winter, reducing energy costs related to the heating system of buildings: on average, the amount of energy used has fallen about 25-30% ([www.iea.org](http://www.iea.org)). The more the increase in electricity and gas prices, the more the decrease in energy demand. Wooden buildings are considered to be more expensive than other kind of buildings, thus people generally back out from investing in this market (Sentman, 2009), and instead the main factors causing these costs are:

- architectural design time, with the support of Computer Aided Design (CAD);
- engineering design time, with the support of Computer Aided Engineering (CAE);
- the relation between demand and supply;
- the cost of materials;

To summarize, the firm “Prefabbricati di Martelli Salvatore & C.” performs its activities in an innovative and growing context, aiming to become a leading sector for EU economy. This firm could be a reference point for both traditional Italian and Sicilian organisations, in terms of green buildings growth of waste generation rates is an important issue in the whole world. In this context the recycling of the valuable components from waste is among the most sustainable options implemented so as to establish a balanced world system. According to Waste Framework Directive (WFD) one of the key issues of a

continuous progress related to eco-efficient waste management consists in ensuring the sustainable management of prevention, control and remediation processes relative to the environmental components, associated in particular to waste minimization and valorization, according to waste management hierarchy. Waste management hierarchy comprises the most and less favorable options for waste management (Ghinea and Gavrilăscu, 2010). Recycling prevents the emissions of gases (GHG), water pollutants, conserves resources and stimulates the development of clean technologies. Energy recovery, known also as waste-to-energy, is carried out through the conversion of non-recyclable waste into fuel, electricity, heat etc. Unfortunately, materials resulting from construction and demolition are often considered as waste for disposal, rather than resources for processing and reuse (Simion et al., 2013). They have negative impacts on environment, economy, public health and social life (SARMa, 2011).

## **2. Materials and methods**

The Cost-Benefit Analysis (CBA) was developed for the first time by the French engineer Jules Dupuit in 1848 and found its first application in the evaluation of federal water projects in the United States in the late 1930s ([www.economicstimes.indiatimes.com](http://www.economicstimes.indiatimes.com))

CBA is an economic method used to analyze and measure in “money terms” all the benefits and costs of a project or investment opportunity considering both quantitative and qualitative factors. The main objective is both to verify the effectiveness of any investment opportunity and give a basis for making comparisons with other offers. This method allows all the positive and negative aspects of the analyzed projects to be identified and quantifies them in monetary terms. The global benefit is the net benefit, obtained by the maximization of the difference between costs and benefits. During the evaluation, it is necessary to consider direct and indirect values. The former directly derives from the project, the activity or the investment considered for the application of the CBA. The latter derives from indirect effects that the activity causes: for this reason, it is harder to find and quantify them. The indirect costs are often connected with environmental matters: it could be hard to give a monetary value to them. In order to evaluate indirect costs, it is possible to consider the potential damage caused to one or more environmental resources, and so, their marginal variation. Thus, it is possible to quantify the extent of the loss of benefits. In an alternative to this indirect method, further methods can be implemented, such as: the contingent valuation, the hedonic pricing method, the travel costing method and the opportunity cost method.

The first is based on asking people how their willingness to pay is, contingent on a specific hypothetical situation of the environmental service ([www.ecosystemvaluation.org](http://www.ecosystemvaluation.org))

The hedonic pricing method reflects the value of local environmental attributes, considering the market prices related to the characteristic of the local services. As far as the travel cost method is concerned, it is based on considering the “price” of access to the site as the time and travel costs that people incur to visit it, estimating people's’ willingness to pay ([www.ecosystemvaluation.org](http://www.ecosystemvaluation.org)).

## **3. Case study: Prefabbricati di Martelli Salvatore & C. s.a.s.**

The Sicilian building sector can boast significant achievements in the field of environmental care and awareness. As a matter of fact, just looking at the firms belonging to this sector is enough to become aware of the great attention they deserve to the environment, such as the Prefabbricati Martelli. This small firm, situated in Bronte (CT), deserves mentioning in this context, first of all because of the environmental certifications it has. The story of Prefabbricati Martelli is mainly based on the traditional values of family and hard work. In the 50s, the main business the firm carried out was the distribution of coal and wood. In the 80s, the firm began to distribute products related to the building sector, specializing its

knowledge and competences related to the construction of wooden roofs. At the beginning of the XXI century, the Prefabbricati Martelli, as it is now known, was created.

The company is nowadays specialized in the production and restoration of wooden structures, whatever their dimensions are. Moreover, it offers consultancy services and produces innovative buildings, revolutionizing the concept of living so that it can fit the one of sustainability. Its plant is 2000mq large and its handling and storage area is 5000m. Furthermore, it is equipped with a numerical control system, qualified suppliers and workers, Computer Aided Design (CAD) tools and a quality control system.

As far as certifications are concerned, the Prefabbricati Martelli deserves to be mentioned because of the great attention paid to this unique symbol of awareness and responsibility. It has: the SOA certification, category OS32 to guarantee the presence of quality in the execution of public works; the UNI EN ISO 9001:2015 to guarantee the quality of its structural elements; the UNI EN ISO 14001:2015 to guarantee the respect of the environment, to underline its real commitment and the desire to control and protect the environment, looking for the continuous improvement.

The firm deals with every single phase of the production cycle: from design and engineering to the realization of any kind of structure, building or anything else made of wood. The strength of Prefabbricati Martelli is that wood has extraordinary features, both from an ecological and economic point of view: it is characterized by durability and good mechanical properties (such as elasticity and easiness to manipulate), it suits the need to respect the environment and to reduce CO<sub>2</sub> emissions and the need to live in anti-seismic homes. Wood has a cellular structure that allows it to preserve and release heat. The fact that it is a great insulator entails a great energetic saving: the transmittance values reach 0.20W/mwK. Thanks to this, a wooden house is fresh in the summer and warm in winter, resulting in a reduction in the use of any heat system. The firm produces building structures, adopting three different building systems: the X-lam system, the frame system and the blockhouse one.

### **3. Results and discussion**

Through the competences and the methodological approach adopted by the firm, buildings are constructed in order to minimize the environmental impact and reduce the construction time and energy consumption that characterize building constructions. The need to build houses with non-impacting materials, using alternative technology, is a priority for the building sector, due also to the energy saving that it entails. But, at the same time, there are many issues that hinder the diffusion and application of construction norms, despite the innovative policies that have been already undertaken by many Public Administrations, both provincial and regional.

Therefore, it is important to show that, although there are great costs due to high initial investments, there will be savings in maintaining the buildings, as well as lower environmental impact (Allesina and Fregni, 2005). Modifying or improving the project during the phase of construction, foundation or while all necessary documents for the administrative practices are being prepared, is considered to be the best choice in order not to delay the start of works and/or, above all, increase costs. A well-organized planning from the start of works can mean an optimization of the energetic resources of the building and, consequently, a reduction of management and energy costs.

Specifically, the investment's costs can be 5% higher, but the annual management costs can be reduced from 40% to 90% (Bertino, 2015). So, in the long term, management and maintenance costs are lowered, whereas the commercial value of buildings is higher than that of "normal" buildings (more or less 4%) ([www.usgbc.org](http://www.usgbc.org)), which do not respect the environment and have higher energy costs.

The benefits already mentioned above are not the only ones related to green buildings: they are not just a way to think about the health of the environment or of people: they represent a valuable example of one of the ways technology can be combined with design and environment.

The principal European legislative tool for the energetic efficiency improvement of European buildings and, above all, for the almost zero energy buildings ("NZEB", from the English Nearly Zero-Energy Buildings) is the directive 2010/31/UE on the energetic performance in the house building ("directive EPBD", from the English Energy Performance of Buildings Directive). The directive EPBD also estimates that members States will make the new buildings, occupied by public corporate bodies and of ownership of the latter, with almost zero energy buildings from December 31 2018 and all the new buildings with almost zero energy buildings within 2020.

The National Plan, therefore, assesses the energetic performances in the different types of use and climatic zones, estimating the greatest necessary costs, in comparison to the actual levels, for the realization of new NZEB buildings or for the existing building's transformation in NZEB and tracing the national development guide-lines to increase their number through the regulation available measures (<http://www.federlegnoarredo.it/>).

It has been estimated that the application of green building doubles every three years globally: the statistic tendencies give evidence that 60% of building projects is oriented toward sustainability. As a matter of fact, all the buildings are undergoing a transformation related to the energy efficiency, since energy consumption in residential buildings represents 38% of Italian energy consumption. In the United States buildings account for almost 40 percent of national CO<sub>2</sub> emissions sustainable buildings have 34 percent lower CO<sub>2</sub> emissions, consume 25 percent less energy and 11 percent less water, and have reduced more than 80 million tons of waste. These results are quite good if projected in the future: the USA is expected to cut energy costs by 1.2 billion and maintenance ones by 715.2 million, between 2015 and 2018 ([www.usgbc.org](http://www.usgbc.org)). In addition, in Italy wooden structures have reached unexpected percentages recently, including both homes for one family to the ones for many families (Fig. 1).

Today it is estimated that 18% of buildings in Italy is made of wood and this number is destined to increase to 30% by 2020 (Promo\_legno, 2015). Thanks to the significant technological development and its fundamental role in the protection of the climate, nowadays it is possible to realize a whole building in a very short time, arousing increasing interest in the green building sector. Consequently, it is expected that from 2021 everyone will build only elevated energy performances buildings. Wooden buildings represent a new cultural approach that combines innovative technologies with traditional ones in a reasonable architecture, which cannot be compared with nature, but respects its laws. Besides, this architecture tries to exploit the natural conditions of the place through simple arrangements in the initial phases, such as the building's shape, its orientation, the disposition of the inside environments, the exposure to the winds, the seasonal variations of temperature, the illumination and the natural ventilation too.

To build using the green building's techniques also means enjoying a superior comfort, having a guarantee of health and psychological benefits. It has been shown that workers' productivity is higher when they work in buildings made of wood, because of their comfortable and hospitable environment. Thus, the way people feel when living in a wooden house makes them peaceful and happy, with great consequences on their well-being. It is also important not to forget that most of the discomforts of this century are caused by environmental pollution: 90% of the air we breathe all day long comes from enclosed spaces, thus there is the necessity to guarantee the indoor comfort of residences and the healthiness of the air. Considering another aspect too, green buildings are made of 100% natural materials, which guarantee correct temperatures in enclosed spaces and high-quality air (Sentman, 2009).

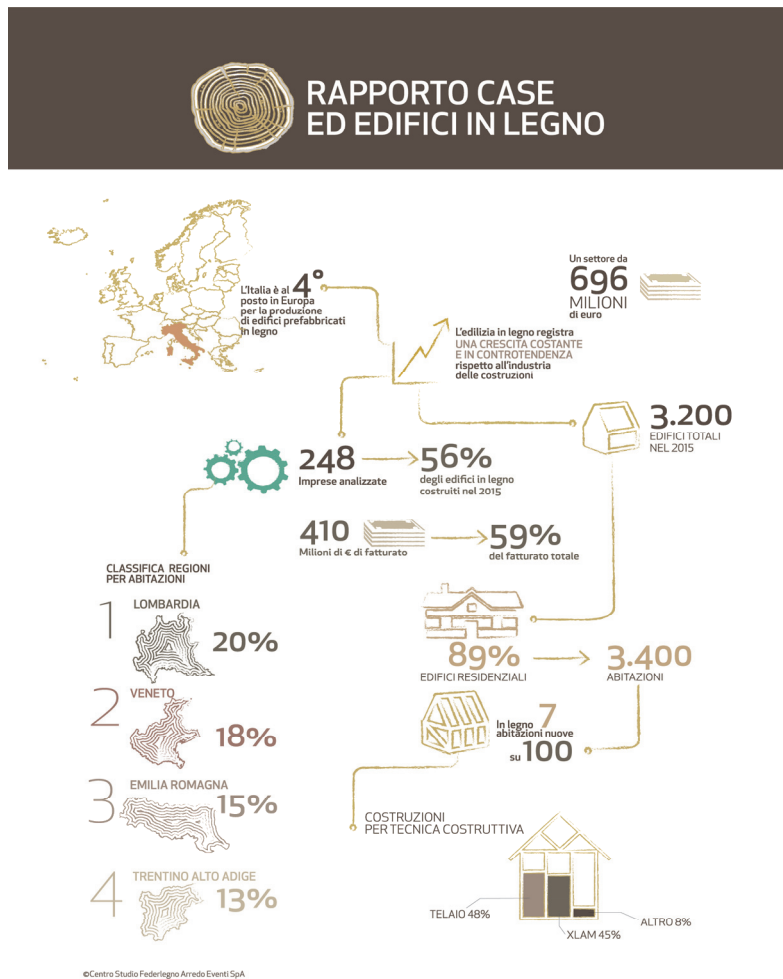
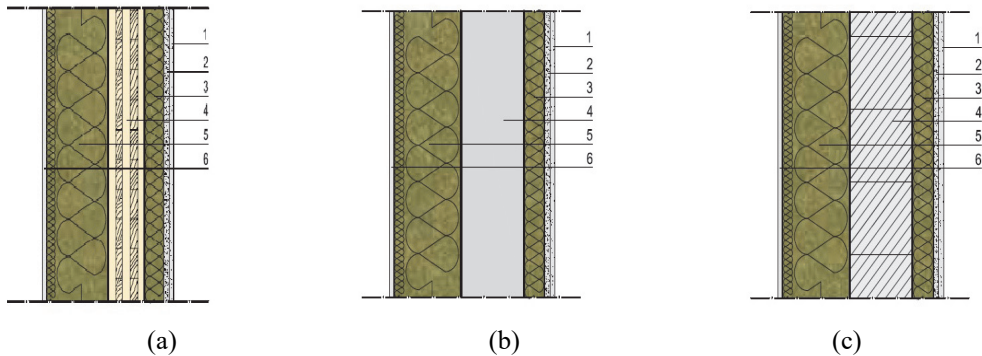

**Fig. 1.** Report 2017 on wooden houses and buildings in Italy. The sector is earning relevance and the energy savings are increasing in comparison with the traditional building sector.

Thanks to these qualities, houses are very comfortable all year round and at whatever time of the day. This is possible especially because they succeed in maintaining a constant temperature, thanks to the equilibrium of the thermal indoor-outdoor interchange, and in reducing energy consumption. Air conditioning or heating systems will not be as used as before, thanks to wood (which has good insulating properties).

Analyzing the stratigraphy of a wooden structure made by Prefabbricati Martelli, using the Cross Laminated Timber (CLT) System (the so-called X-lam panel), it is possible to show that the thermal and acoustic insulation is relevant, due to the low specific weight of materials. The analyzed wooden wall has the following stratigraphy: plasterboard sheet (n.1 in Fig.2), fiber sheet (n.2 in Fig.2), rock wool (n.3 in Fig.2) with a density of  $70\text{kg/m}^3$  and 50mm thick, X-lam panel (n.4 in Fig.2) 95mm thick, rock wool panel (n.5 in Fig.2) with a double density equal to  $155\text{-}80\text{ kg/m}^3$  and 160mm thick, final panel (n.6 in Fig.2). The thermal performances of the wall's stratigraphy show that the thermal transmittance is equal to  $0.14\text{ W/m}^2\text{K}$  and assume significant values if compared to other construction materials.

The thickness of the wall is 34 cm. To reach the same thermal result with brick (traditional building sector), it is necessary to reach a thickness of 55 cm.



**Fig. 2.** In order of comparison: (a) the X-lam panel, (b) the concrete panel, (c) the punctured brick panel.

The comparison among three different constructive solutions (X-lam, concrete and punctured brick one) with different leading elements but the same thickness and the already mentioned stratigraphy has shown that the X-lam panel is characterized by performances better than the others (Fig. 2). As a matter of fact, the thermal wave takes on 16 hours to pass through the X-lam panel, 12 hours to pass through the concrete and 13 hours to pass through the punctured brick. Moreover, the first one has a transmittance of  $0.14 \text{ W/m}^2\text{K}$ , the second one of  $0.16 \text{ W/m}^2\text{K}$  and the third one of  $0.15 \text{ W/m}^2\text{K}$ . Consequently, a house built with the X-lam system is warm in winter and fresh in summer.

#### 4. Concluding remarks

Considering the advantages already mentioned, there is no reason why people should not adapt to these amazing changes: wooden buildings are the best example of green structure, since wood is a natural element. Recently the tendency to choose buildings with high thermal performances has caused a cultural change, related to the spread of wood in the building sector, combining excellent thermal performances with high quality.

Moreover, it has been shown that the new wooden buildings need less material to produce better performances than traditional ones. A well-built wooden structure is excellent for satisfying people both in winter and in summer.

#### References

- Allesina A., Fregni M.C., (2005), Comparative assessment of the costs of a building in green building (in Italian: Valutazione comparativa dei costi di un edificio in bioedilizia), COS.E.BIO COSTi Edificio BIOedile, On line at: <http://biblus.acca.it/valutazione-dei-costi-di-un-edificio-in-bioedilizia-e-suoi-parametri-prestazionali/>
- Bertino R., (2015), Domus Magistra: The house that teaches how to build houses (in Italian: Domus Magistra: La casa che insegna come si costruiscono le case), *Il Mondo Tradimalt*, 39-42, On line at: <https://www.infoarredo.it/rubriche/art-624-domus-magistra-la-casa-che-insegna-come-si-costruiscono-le-case>.
- Ghinea C., Gavrilesu M., (2010), Decision support models for solid waste management - An overview, *Environmental Engineering and Management Journal*, **9**, 869-880.
- Harvey F., (2009), Efforts increase to improve sustainability, *Financial Times*, On line at: <https://www.esbny.com/efforts-increase-improve-sustainability>.

- Promo\_legno, (2015), Wood and the city: intervenire nel tessuto urbano, *Materialelegno*, **5**, 1-31.
- SARMA, (2011), *The Production of Recycled Aggregates from Inert Waste*, Press Centre of Emilia Romagna-Region, Bologna, Italy, On line at:  
[http://www.sarmaproject.eu/uploads/media/SARMA\\_Manual\\_CDW.pdf](http://www.sarmaproject.eu/uploads/media/SARMA_Manual_CDW.pdf)
- Sentman S.D., (2009), Healthy buildings: Green building standards, benefits, and incentives, *The Journal of Biolaw & Business*, **12**, 1-4.
- Simion I.M., Ghinea C., Maxineasa S.G., Taranu N., Bonoli A., Gavrilesco M., (2013), Ecological footprint applied in the assessment of construction and demolition waste integrated management, *Environmental Engineering and Management Journal*, **12**, 779-788.

**Websites:**

- <http://www.dime-eu.org/files/active/0/Cooke-2010-Fang-Green-building-review.pdf>
- <http://economictimes.indiatimes.com/definition/cost-benefit-analysis>
- [http://www.ecosystemvaluation.org/contingent\\_valuation.htm](http://www.ecosystemvaluation.org/contingent_valuation.htm)
- <http://www.federlegnoarredo.it/associazioni/assolegno/approfondimenti-news/edifici-nzeb-pronto-il-piano-di-azione-nazionale>
- <https://www.iea.org/newsroom/news/2016/october/energy-efficient-prosperity-green-buildings.html>
- <http://www.reportlinker.com/p04047030/Global-Energy-Efficient-Building-Market.html2020>
- [http://www.struttureinlegnomartelli.it/79/1/Strutture\\_in\\_legno\\_a\\_Catania/](http://www.struttureinlegnomartelli.it/79/1/Strutture_in_legno_a_Catania/)
- <https://www.usgbc.org/articles/green-building-facts>



Procedia Environmental Science, Engineering and Management 4 (2017), (3) 191-197

21th International Trade Fair of Material & Energy Recovery and Sustainable Development,  
ECOMONDO, 7th-10th November, 2017, Rimini, Italy

---

## **MASS BALANCE AS ECONOMIC AND SUSTAINABLE STRATEGY IN WEEE SECTOR\***

**Giovanna Tuccio<sup>1\*\*</sup>, Pietro Bua<sup>1</sup>, Giuseppe Teodoro<sup>1</sup>,  
Francesco Failla<sup>2</sup>, Vincenzo Antonio Giuffrida<sup>2</sup>**

<sup>1</sup> *University of Catania, Departments of Economics and Business,  
55 Corso Italia 95129 Catania, Italy*

<sup>2</sup>*FG srl Belpasso (Catania) Strada Comunale San Todaro, 20, Italy*

---

### **Abstract**

This paper aims to provide an explanation of Waste of Electric and Electronic Equipment (WEEE), a concept associated with the disposal of large household appliances such as fridges. The significance of innovation and technological knowledge has caused the development of a new industrial progress and represented the main reason of increased production of goods and services. Growth in the modernization of the hi-tech sector has risen quickly: in the IT industry the updating of Electric and Electronic Equipments (EEE) and its planned obsolescence have become two of the fastest growing waste streams in a global context. By describing the large amounts of e-waste and the hazardous substances within it (i.e. heavy metals, CFCs, pentane), the most virtuous companies are working to introduce new criteria in evaluating the environmental costs related to the economic degeneration of natural resources and the negative impact of economic activities on environmental pollution (e. g. CO<sub>2</sub> emissions). The project developed a perspective which focuses on sustainable accounting and the use of environmental accounting tools. It investigates environmental and economic dimensions in the e-waste sector, considering material flows recovered from the treatment plant of a Sicilian firm. While the traditional accounting methods assess the economic and environmental performance of a human-dominated ecosystem separately, modern accounting demonstrates a new adaptive management tool which needs to be implemented by companies. The study highlights the Mass Balance analysis, which is an approach capable of linking economic and ecological dimensions together. In evaluating eco-efficiency the ideology behind the e-waste sector is to produce secondary raw material in step with the Circular Economy model. In the Green Economy overview, sustainable consumption raises awareness and technological progress involves economizing on the use of raw materials, downsizing the disposal of Electric and Electronic Equipments and re-using waste materials.

---

\*Selection and peer-review under responsibility of the ECOMONDO

\*\* Corresponding author: e-mail: [giovannatuccio.gt@gmail.com](mailto:giovannatuccio.gt@gmail.com)



*Keywords:* Circular economy; Environmental accounting; Green economy; Mass balance; Sustainability

---

## **1. Introduction**

This experimental investigation carries out research into the key factors that are focused on the Environmental Accounting and on accounting and reporting tools of environmental concerns too (Hopwood et al., 2010; Pasetti et al., 2014).

Since the 1990s empirical studies rotated around the connection between accounting and sustainability to perceive how accounting technologies can handle the issues and the evolution of sustainable development. In this perspective the study highlights a general framework which tends to materialize environmental phenomena development within well-defined procedures. Moreover, it aims to protect, restore and manage (Committee on Environmental Research, 1993). Therefore, this framework underlies the prevention of unethical behaviour and the pervasiveness of wrong practices in so far as it follows devastating effect. It is clear to see, in an international or in a national sphere, how the concept based on “Environmental Accounting” becomes a shared feeling. In this sense, a resolute judgment of legitimacy restoration and firm reputation are both significant traits to restore or carry on the relationship on the basis of which business entities may draw sustainable resources and support from their environment (Hopwood et al., 2010; Mocciaro Li Destri, 2013).

Environmental Accounting is a discipline which is not so clearly defined by the existing doctrine. It is a theoretical scheme which represents a pragmatic approach useful to identify and quantify the interchange between environmental and economic systems. Moreover, this theoretical scheme represents a pragmatic approach capable to take into account natural stock flows and their changes in observing the consequences of human acts on the environment (Giovannelli et al., 2005). The main theme of sustainable accounting procedures links regulatory interventions and key environmental indicators with the aim of attributing an economic value to the natural components both at the micro-economic (business unit) and macro-economic (country-system) level. There is more interest about Environmental Accounting (EA) as an innovative methodology which is implemented in different spheres (i.e. for profit/non-profit companies or public entities) (Clasadonte et al., 2005). Its purpose is to provide answers on the environment and its own strategic variables embedding new assets along side of traditional accounting systems. This concept makes it possible to evaluate efficiency and productivity of management control: sustainability should be implemented into organizational processes for economic and moral reasons (Hopwood. et al., 2010).

Certainly, from the managerial point of view the implementation of EA’s framework may only create a really positive influence if it supports sustainable development-oriented of an entrepreneurial entity in changing and if it minimizes the adoption of natural resources (Figge and Hanh, 2013). Thus, the aim of the present study is to perform an analysis of an entrepreneurial entity such as FG S.r.l which is the Sicilian benchmark of entrepreneurship in the sector of West of Electric and Electronic Equipment. In particular, the activity of FG S.r.l. is devoted, according to the Italian legislation implementing the EU Directive in Legislative Decree of March 14, 2014, n. 49 (known as “RAEE Decree”), to the selection of WEEE from which recycling Secondary Raw Materials and reporting into Mass Balance its outputs. The paper is divided into seven parts: Section 2 “Materials and methods” explains the material and methods which can be summarized as the main tool of this study called Mass Balance; Section 3 “Case study” explains and describes the case study of FG S.r.l, its story and its production cycle; Section 4 “Experimental” is focused on empirical phases of the Mass Balance’s implementation at the company level; Section 5 “Results and

discussion” presents the results; Section 6 “Conclusions” outlines the final considerations for the sector and, lastly, in Section 7 there are “References” which shows authors consulted.

## **2. Materials and methods**

Usually the recycling of WEEE provides the recovery of precious elements, which can be reused as secondary raw materials: however, this involves the adoption of authentic treatment processes to realize specific standard dispositions (La Marca, 2012). The present survey is based on qualitative-longitudinal analysis of FG S.r.l.’s case study obtained by primary data collection methods based on data set implementation (Mass Balance) and secondary data information such as research projects, conference material and written documents obtained from reports or correspondence. So far a well-known measurable method does not exist to classify environmental data. Therefore, firms adopt a “half-way sustainable approach” (Milne et al., 2009) which focuses on profits rather than sustainable frameworks. However, today a favorable turnaround of a sustainable development in recognizing the need of an indirect accounting system which subsumes environmental phenomena (Milne et al., 2006). This empirical research, selected on the mass Balance’s principle for the large house hold (HH) appliances, emphasize three main reasons researched into the Circular Economy overview:

- The company examine, FG, is one of the most important entrepreneurial entities in WEEE management, operating in respect of environmental and quality certifications. Moreover, in accordance with the normative standards on environmental protection the company has permission for the processing, storage and the transport of special hazardous waste and non-hazardous waste (<http://www.fgambiente.com/autorizzazioni>):

- ISO 14001 (Environmental Management System)
- ISO 9001 (Quality Management) and the European accreditation WEELABEX standard treatment (WEELABEX organization confirm the protocol for FG since 21th September 2015 until 20th September 2017, Certificate N. 14-0016);
- The company represents a business unit with a flexible vision created by a collaborative asset.

Widespread ideas thanks to the correct treatment of the WEEE from which FG adopting a proactive internal model that identifies secondary raw materials (Hischier et al., 2005), and their respective qualities in raising a co-operation strategy based on a relevant internal and collaborative staff control in using Best Available Technologies in its plant.

FG provides a combined approach founded on annual data collection (for the 2016) derived from the material flows entering as input and leaving as output into the plant. Mechanism of Legal compliance and proactive management of some environmental concerns influence the use of environmental performance indicators. Peculiarly, environmental performance indicators are adopted for waste management, environmental resources, air emission and water use cost reduction. Empirical studies have shown that companies make investments in sustainability management and external reports to intensify visibility and to inform stakeholders (Perrini et al., 2007). In this sense, accounting and reporting tools for the analysis of environmental and social issues can be cataloged under the extensive logical intuition within sustainability accounting (Schaltegger and Burritt, 2010; Tinker and Gray, 2003).

Environmental indicators are essential tools for tracking environmental progress, supporting policy evaluation, strategies and performance, and informing the array of stakeholders too (OECD Environment Directorate, 2008). The important implication which is relevant for this current project is to demonstrate how Italians, and particularly local firms using the Environmental Accounting approach in their own activities are capable to implement innovative sectors. Moreover, the key approach in developing this perspective is draw on an adaptive management tool which FG uses in its processes to implement WEEE

management and observe technological progress over time too. By considering the connection between the industrial and the environmental dimensions, the implemented model importing data from Excel Spreadsheets shows the critical secondary materials obtained from a percentage analysis.

### 3. Case study: FG S.r.l.

FG S.r.l. is the most important Sicilian family business Appliance Recovery and Recycle organization and is today's clear leader in the sector of West of Electric and Electronic Equipment. The story of the firm is based on a steady improvement in environmental performance, on the one hand, magnifying the recovery of secondary raw and, from the other, reducing environmental risk. Founded in 1974, by the entrepreneur Failla Giovanni, and operational since the 2008, in Waste of Electric and Electronic Equipment, actually, FG Ltd. is a family-controlled company in with Failla Salvatore is the sole director and his brothers, Francesco and Massimo, are business partners. FG is situated in Belpasso (CT), covering an area of over 19.000 m<sup>2</sup>, (of which over 6.500 m<sup>2</sup>) and 5.000 m<sup>2</sup> expanding, and employing 60 workers. The family-run company operates with individual, companies and public bodies, holding the following standards: ISO14001–ISO 9001–ADR – BAT. The establishment has been equipped with complete processing plants for the treatment of potentially polluting materials and for maximum reuse of recyclable raw materials. WEEE is handled differently by the disposal facilities according to the 5 groupings: **R1** (cooling & freezing equipment) Refrigerators, air-conditioners, freezers etc; **R2** (large household appliances) washing machines, dishwashers, extraction bonnet etc; **R3** (TVs & monitors) televisions and CRT, LCD or plasma screens etc; **R4** small household appliances mobile phones, computers, electronic toys, lighting equipment, etc.; **R5** light sources low energy light bulbs, neon light bulbs etc. the plants of FG S.r.l are the following: **R1**: disassemble and drainage system of raw materials which correspond to the R1. **Step 1** – removal of different detachable components (glass, cables, condensers) in big bags; **step 2** – degassing/drainage of the cooling circuits which is (in 8-10 minutes) tapped and exhausted by grippers and drill heads: separating recovery of pentane, CFCs and oils; **step 3** – disassembly and security area in which the compressor is separated from the pump head/motor, so the remaining oil is decanted into a recovery container; **step 4** – crushing primary area in which, residual CFC/pentane's components injected in the polyurethane part, have been recovered. Immediately after, the machine screening and separating ferrous pieces from non-magnetic materials carried on conveyors vibrating feeders, achieving an output ready for sale. **Step 5** – crushing secondary area: screening and separating the pure foam from material stream and metal separating regain aluminum, copper and plastics collected. **R2**: waste treatment plant of non-hazardous white goods by chipping or grinding CathodeRayTube: manual disassembly of R3 (TVs & monitors) and R4 (small household appliances) groups; bulky waste: processing techniques of woody or metallic waste (mattress, sofa, furniture, etc), by crushing, separating ferrous pieces and selecting.

### 4. Experimental

Figures 1-2 show the results of a method for the recycling of all materials recovered by the electronic equipment waste treatment procedures. The secondary raw materials are expressed by the percentage analysis of fractions resulting from the sorting, dismantling and recycling processes of Large House Hold Appliances. From the collected data resulting by the treatment phases, it is possible to see how many elements can be re-used as new resources.

Therefore, this process allows to minimize the deposited materials which are destined to incineration or land filling. An overview of the system is shown in Figs. 1, 2.

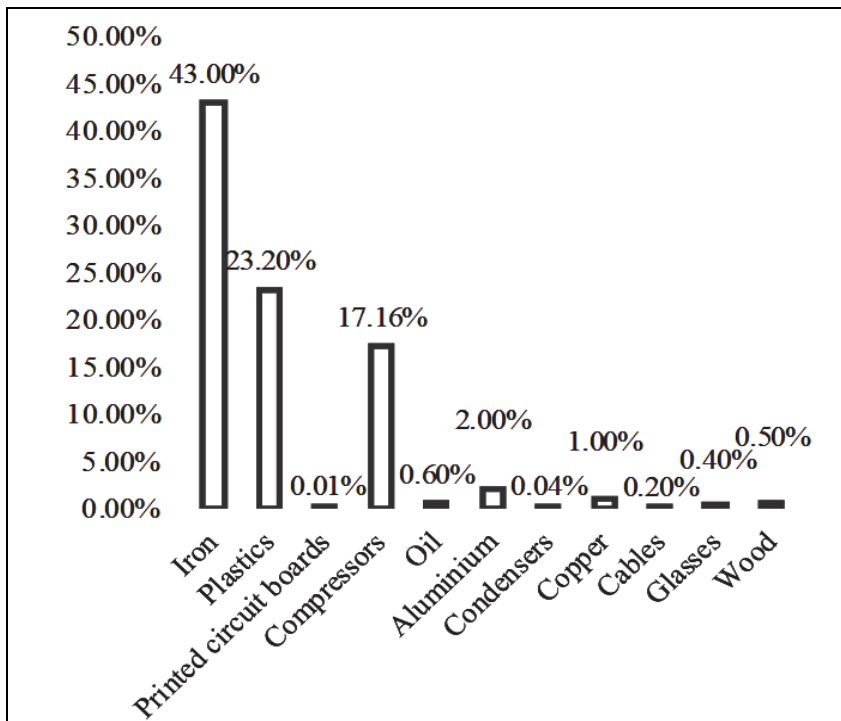

Fig. 1. Weight (%) of large HH recovery

Fig. 1 shows a lot of components such as: iron (EWC 19.12.02) for 43.00%; plastics (EWC 19.12.04) for 23.00%; compressors (EWC 16.02.16) for 5.40%; aluminum (EWC 19.12.03) for 2.00%; copper (EWC 19.12.03) for 1.00%. However, many elements don't exceed the unit value such as: oil (CER 13.02.08) for 0.60%; wood (EWC 19.12.07) for 0.50%; glasses (EWC 19.12.05) for 0.40%; cables (EWC 17.04.11) for 0.20%; condensers (EWC 16.02.09) for 0.04%; printed circuit boards (EWC 16.02.16) for 0.01%.

The company recovery 100% of iron, plastics, printed circuits board, compressors, aluminum, copper, woods and cables, instead, the firm recycling 95.00% of oil and 93% of plastic and glasses.

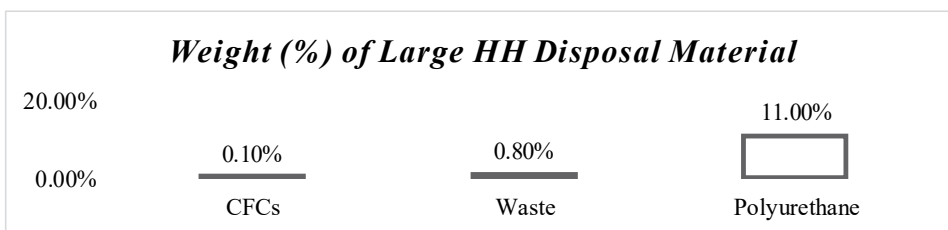

Fig. 2. Weight (%) of large HH disposal material

Fig. 2 depicts the materials disposed and their quantitative. There are CFCs (EWC 14.06.01) for 0.10%; waste (EWC 19.12.12) for 0.80% and, lastly, polyurethane for 11.00%.

According to FG S.r.l. the amount of WEEE recycled are 88.10%, instead disposed materials are 11.10%.

## 5. Results and discussion

This article uses the *mass balance approach* to describe how the environmental strategy of FG S.r.l. is rooted in an assessment which can affect the ecological side of the organization. The e-Waste Mass Balance of Large House Hold (HH) Appliances is discussed further. Table 1 shows the percentage points for the different range of materials found in e-waste of large HH. This analysis underlines categories of secondary raw materials such as Iron which represents the highest value (43.00%), to follow Plastic (23.20%), indeed, the precious non-ferrous materials such as aluminum by weight representing 2.00% and Copper that represents 1.00%.

Looking at the minimum recovery targets applicable until 14 August 2018 to the categories listed in the Annex II (WEEE Directive – n. 49/2014) falling within category 1 (Large House Hold Appliance) provided for e-waste referred to the present list the 85% will be recovered. The treatment operations carried out by the Mass Balance of FG are in accordance with the normative standards for 88.10%. Furthermore, this result shows how the firm is the leader in the large house hold treatment: certainly, using the best available techniques FG ensures a proper treatment which highlights a rise of 3.00%. The empirical analysis here developed confirms that the company have been working towards sustainability efforts. This responsibility's effort reveals a positive opportunity, not only for the firm's reputation as an environmentally efficient system, but also, to demonstrate how the company is able to achieve a competitive advantage in monitoring and controlling its environmental, economic and social issues: relevant data could support strategy decisions to develop a sensible perspective in evaluating alternative sources for the future research.

**Table 1.** The mass balance of large household

<i>E.W.C. Code</i>	<i>Recovered materials</i>	<i>Recovery percentage</i>
19.12.02	Iron	<b>43.00</b>
19.12.04	Plastic	<b>23.20</b>
16.02.16	Compressors	<b>17.16</b>
19.12.12	Polyurethane	<b>11.00</b>
19.12.03	Alumin	<b>2.00</b>
19.12.03	Copper	<b>1.00</b>

## 6. Conclusions

The model presented here provides insight into how Mass Balance approach appears at the level of the individual firm. It is important to consider through public documents, reports and articles the possibility to demonstrate that companies. This lack of interest demonstrates how the economic entities are reluctant to use environmental accounting systems.

The use of technologies accounting such as EA and its own tools have been considered ideological weapons in the social construction of sustainability. In conclusion, it is possible to lay the groundwork for future research, to both achieve new competitive advantages.

## References

- Clasadonte M., Matarazzo A., Sabbia A., Bruno B. V., (2005), *Linee guida di contabilità ambientale degli enti territoriali. Il comune di Catania*, Tipolito Gullotta s.n.c., Catania, 36-37.
- Committee on Environmental Research, (1993), *Research to Protect, Restore, and Manage the Environment*, National Research Council, Division on Earth and Life Studies, Commission on Life Sciences, Committee on Environmental Research, The National Academies Press, Washington DC, <https://doi.org/10.17226/2216>.
- Figge F., Hanh T., (2013), Values drivers of corporate eco-efficiency: management accounting information for the efficient use of environmental resources, *Management Accounting Research*, **24**, 387-400.
- Giovannelli F., Di Bella I., Coizet R., (2005), *Nature in the Account* (in Italian: *La natura nel conto*), Edizioni Ambiente, Milan, Italy.
- Hischier R., Wäger P., Gaughhofer J., (2005), Does WEEE recycling make sense from an environmental perspective: The environmental impacts of the Swiss take-back and recycling systems for waste electrical and electronic equipment (WEEE), *Environmental Impact Assessment Review*, **25**, 525-539.
- Hopwood A., Unerman J., Fries, J., (2010), *Accounting for Sustainability: Practical Insight*, Routledge, London.
- La Marca F., (2012), *Control and Characterization of Materials Recovered from Mechanical Recycling of Waste Refrigerators*, 9th International Conference on Measurement and Control of Granular Materials, MCGM 2011 - Global High Level Academic Seminar, 27 October 2011 through 29 October 2011, Shanghai (China), Vol. 508, 207-211.
- Milne M.J., Kearins K., Walton S., (2006), Creating adventures in Wonderland: the journey metaphor and environmental sustainability, *Organization*, **13**, 801-839.
- Milne M.J., Tregidga H.M., Walton S., (2009), Words not actions! The ideological role of sustainable development reporting, *Accounting, Auditing & Accountability Journal*, **22**, 1211-1257.
- Mocciaro Li Destri A., (2013), *Managerial Irresponsibility and firm survival. Pivoting the Company in the Aftermath of a Social Scandal*, Franco Angeli, Milan, Italy.
- OECD Environment Directorate, (2008), *OECD Key Environmental Indicators*, Paris, France.
- Passetti E., Cinquini L., Marelli A., Tenucci A., (2014), Sustainability accounting in action: lights and shadows in the Italian context, *British Accounting Review*, **46**, 295-308.
- Perrini F., Russo A., Tencati A. (2007), CSR strategies of SMEs and large firms. Evidence from Italy, *Journal of Business Ethics*, **74**, 285-300.
- Schaltegger S., Burritt R., (2010), Sustainability accounting for companies: catchphrase or decision support for business leaders, *Journal of World Business*, **45**, 375-384.
- Tinker T., Gray R., (2003), Beyond a critique of pure reason: from policy to politics to praxis in environmental and social research, *Accounting, Auditing & Accountability Journal*, **16**, 727-761.





Procedia Environmental Science, Engineering and Management 4 (2017) (3) 199-205

21th International Trade Fair of Material & Energy Recovery and Sustainable Development,  
ECOMONDO, 7th-10th November, 2017, Rimini, Italy

---

## **CARBON DIOXIDE BALANCE OF WOODEN STRUCTURES: CIRCULAR ECONOMY IN THE ECOLOGICAL BUILDING INDUSTRY\***

**Domenico Licciardello<sup>1</sup>, Sefora Leah Spatafora<sup>1</sup>, Ludovica Vizzini<sup>1\*\*</sup>,  
Cinzia Martelli<sup>2</sup>, Claudio Francesco Vincenzo Martelli<sup>2</sup>**

<sup>1</sup>*Department of economics and business, University of Catania, Corso Italia 55, 95129, Catania, Italy,*

<sup>2</sup>*Prefabbricati di Martelli Salvatore & c. Sas, Viale Kennedy, 95034, Bronte (Ct), Italy*

---

### **Abstract**

One of the major causes of CO<sub>2</sub> emissions is the construction sector. This is due to the fact that the construction industry uses untreated materials which generate noise, dust and a considerable amount of waste. Moreover, the production and use of these materials has an enormous environmental impact because cement is an energy consumer and one of the largest CO<sub>2</sub> producers. Other factors and causes of CO<sub>2</sub> emission are products that use high temperature processes to produce elements such as cement and bricks; these are considered as a main user of energy and emitter of greenhouse gases. The construction sector can reduce emissions of carbon dioxide, over the short and long term, through the choice of materials with a low environmental impact and through energy-efficient structures. Increasing the use of wood products is part of the solution. In fact, the use of wood, in the construction industry is an effective way to reduce CO<sub>2</sub> emissions because it is the only renewable construction material and the only building material that has positive effects on the CO<sub>2</sub> balance. By using wood, the carbon footprint of the structures is reduced in two important ways: wood is the only major building material that stores carbon, thus keeping it out of the atmosphere and secondly by using it, instead of steel or concrete, means less fossil fuel consumption and, as a result, less greenhouse gas emissions. On the other hand, wood is made using energy from the sun, so manufacturing wood requires less energy than other materials. Wooden structures are characterized by a combination of different components that together deliver the best possible load-bearing capacity, thermal, acoustic and moisture insulation, fire resistance and a long service life. To this end, a leading industry in the production of prefabricated wooden structures, located in eastern Sicily, has been investigated.

*Key words:* building materials, carbon dioxide balance, construction industry, greenhouse emission, wooden structures.

---

\*Selection and peer-review under responsibility of the ECOMONDO



\*\* Corresponding author: e-mail: ludovica.vizzini1995@gmail.com; madden95@hotmail.it

## 1. Introduction

Sustainability is now a key concept in development thinking at all levels. One of the most polluting sectors of our time is the building sectors. Buildings are responsible for significant material and energy consumption in industrial societies. They account for one-sixth of the world's freshwater withdrawals, one-quarter of its wood harvest, and two-fifths of its material and energy flows (Augenbroe et al., 1998). In fact this sector increases the production of toxic emission that contaminates our water, soil and air in massive and radical way. Some of the worst consequences caused by the building sector are CO<sub>2</sub> emissions which increase the green house effects. Recently the way to approach this kind of sector has changed, in fact innovation in constructive process and the refinement in material choice creates the ecological building structure. *"There is a growing awareness that in the choice of building materials, the designer must not only consider the traditional requirements of the owner and occupants of the building, but also the resource base and the elects on the environment of extraction, manufacture and processing of the building materials"* (Buchanan and Honey, 1994).

There have been more studies of various building materials and components: a guide to green building materials has been compiled (AIA, 1999) and the energy use and greenhouse gas emissions (except for the end-of-life phase) for wood, steel, and concrete structural commercial building frames have been compared (Canadian Wood Council, 1997; Cole, 1999). A study conducted by the Department of Civil Engineering at the University of Christchurch, New Zealand examined life cycle impacts of the use of concrete, wood, and steel for various components of a single-family residential structure. Energy use and carbon emissions from raw material extraction through building construction were the focus of the study which considered alternative house frame, flooring, and wall systems. Taking into account the fact that wood is about one-half by weight carbon, the analysis showed concrete construction to result in greater net carbon emissions than either wood or steel in both floor and wall systems. Carbon stored within wood is greater than total net carbon emissions associated with harvesting and processing of wood. Another study, this conducted by the Consortium for Research on Renewable Industrial Materials (CORRIM) examined concrete block and wood-frame construction options for a typical home built in the Atlanta metropolitan area (Lippke et al., 2004). Construction activity contributes to the loss of soil and agricultural land in several ways: agricultural land is often lost through the activities of quarrying and mining for the raw materials used in construction. It similarly contributes to the loss of forests and wild lands by their conversion to other uses; by the use of timber to provide energy for building materials production and, indirectly, by the atmospheric and water pollution consequences of construction and building materials production activities.

Further, construction contributes to air pollution at all levels. It creates air pollution at a local scale through emissions of dust, fibre, particles and toxic gases. It contributes to regional pollution through emissions of nitrogen and sulphur oxides in building materials production and it contributes to pollution on a global scale in two important ways: by the use and release of chlorofluorocarbons (CFCs) in buildings contributing to the depletion of the atmospheric ozone layer, and by the emission of carbon dioxide and other greenhouse gases. Finally, the construction industry is a major user of the world's non-renewable energy sources and minerals (Spence and Mulligan, 1995). Some authors such as Goldenberg calculate that a third of the energetic expense, and therefore of the production of this gas, comes directly or indirectly from the construction activity. Others, like Webb or Edwards and Hyett, cited by Gonzalez and Garcia Navarro (2006) more precisely state that a participation of close to 50% of the total energetic cost in developed countries is closely linked or is a consequence of the construction industry.

The purpose of this study is to show how the use of wood in construction is an effective way of reducing greenhouse emissions. In fact, one tonne of carbon is absorbed for every cubic meter of wood; this is possible only through new methods, for example reducing the CO<sub>2</sub> emissions produced by the building sector by transforming the way buildings are designed and built. Increasing the use of wood material in construction is a potential option for reducing net CO<sub>2</sub> emission because of the relatively low energy needed to manufacture wood products compared with alternative materials, the storage of carbon in wood building materials, and the increased availability of biofuels from wood by products. CO<sub>2</sub> is released during the manufacture of Portland cement, when calcium carbonate is heated and broken down into calcium oxide and CO<sub>2</sub>. Cement production is the largest source of non-energy-related industrial emission of CO<sub>2</sub>. Approximately 0.5 tonnes of CO<sub>2</sub> is released for each tonne of cement produced (IPCC, 1996). In 2014, GHG emissions generated by industries and households in the EU-28 stood at 4.4 billion tonnes of CO<sub>2</sub> equivalents. Households accounted for 19 % of greenhouse gas emissions. In 2014, the EU-28's greenhouse gas emissions by industries and households were 8 % lower than they had been in 2009: 395 million tonnes less of CO<sub>2</sub> equivalents were emitted in 2014. Households in the EU-28 reduced their emissions by 102 million tonnes of CO<sub>2</sub> equivalents (a reduction of 11 %) between 2009 and 2014.

## **2. Material and methods**

The Intergovernmental Panel on Climate Change (IPCC) states that the manufacture of wood products normally requires less energy than that of alternative products (IPCC, 1996). With new technologies constantly being developed to complement current practices in creating greener structures, the benefits of green building can range from environmental to economic and social benefits. By adopting greener practices, maximum advantage can be taken from environmental and economic performance. Green construction methods when integrated into a construction cycle while design and construction provide most significant benefits. The benefits of green building include:

### *Environmental Benefits:*

- Reduce wastage of water;
- Conserve natural resources;
- Improve air and water quality;
- Protect biodiversity and ecosystems.

### *Economic Benefits:*

- Reduce operating costs;
- Improve employee productivity;
- Create markets for green products and services.

### *Social Benefits:*

- Improve the quality of life;
- Minimize strain on local infrastructure;
- Improve worker health and comfort.

The USEPA states “*Green building is the practice of creating structures and using processes that are environmentally responsible and resource-efficient throughout a building's life-cycle from siting to design, construction, operation, maintenance, renovation and deconstruction. This practice expands and complements the classical building design concerns of economy, utility, durability, and comfort. Green building is also known as a sustainable or high performance building.*” (USEPA, 2016) So, the aim of green building is to create comfortable places in which the quality of life is better.

The advantages in the use of natural raw materials can be determined effectively by means of the quantification of the CO<sub>2</sub> equivalent. A method can be used to estimate the net CO<sub>2</sub> emission from the construction of wooden buildings. The carbon footprint of building a house depends on all kinds of things – including, of course, the size of the house and the types of materials chosen. Data on the energy input and CO<sub>2</sub> emission for the production of different building materials vary in different studies. For example, the energy used in plywood production is estimated to be much higher in a Dutch study (Worrell et al., 1994), than the data used in Borjesson and Gustavsson (2000) study based on the investigation of Fossdal (1995).

The data on the energy use for the production of other wood products, as well as of steel, concrete and aluminum, also vary in the literature (Buchanan and Honey, 1994; Fossdal, 1995; Worrell et al., 1994). The data will also depend on the production techniques used. A link between exposure to pollutants indoor places and some diseases has been demonstrated. As a matter of fact, we are talking about “sick building syndrome” (SBS). To value the impact of the materials used in the sector of the buildings, in fact, it is possible to adopt tools such as Carbon Footprint: a measure that expresses in CO<sub>2</sub> equivalent the total of the emissions of greenhouse gases associated with a product, an organization or a service. Typically, a carbon footprint is calculated by estimating, as already stated, not just the CO<sub>2</sub> emissions that the activity causes, but also any emissions of other greenhouse gases (such as methane and nitrous oxide) and in some cases other types of climate impacts as well, such as vapour trails from aeroplanes. For simplicity, all these impacts are added together and expressed as a single number in terms of carbon dioxide equivalent (CO<sub>2</sub>e): the amount of CO<sub>2</sub> that would create the same amount of warming.

In accordance with the Protocol of Kyoto, a carbon footprint considers all six greenhouse gases: Carbon dioxide (CO<sub>2</sub>), Methane (CH<sub>4</sub>), Nitrous oxide (N<sub>2</sub>O), Hydrofluorocarbons (HFCs), Perfluorocarbons (PFCs) and Sulphur hexafluoride (SF<sub>6</sub>). The measurement of the Carbon Footprint of a product or of a process require in particular the identification asks particularly for the individualization and the quantification of the consumption from raw materials and from energy in the selected phases of the cycle of life of the same thing. The Carbon Footprint label is perceived by consumers as an index of the quality of the enterprise. The companies, as well as conducting the analysis and the recording of the emissions of CO<sub>2</sub>, undertake to define a system of carbon management aimed at the identification and carrying out intervention to reduce the emissions, economically viable, that use technologies to lower carbon content. All buildings are undergoing a transformation aimed at the improvement of energy efficiency, considering the fact that in Italy the consumption of energy in residential buildings represents 30% of the national consumption and 25% of CO<sub>2</sub> national total emissions.

### **3. Experimental**

The company studied is a family company called “Prefabbricati di Martelli” located in southern Italy, in eastern Sicily. “Prefabbricati di Martelli” is a company leader in the construction of wooden structures and buildings, which follows the green building principles. A 2000m<sup>2</sup> factory, a 5000 m<sup>2</sup> handling and storage area, a CNC system of the last generation, CAD design tools, a certainly confident know-how, a group of competent and up-to-date worker, qualified suppliers, expert planners and a series of measures of control able to guarantee the quality of the project answers, make Prefabbricati Martelli a reference point in the sector. The company is specialized in the construction of wooden structures, both in the private and in the public sector. It offers services of advice and design, realizes buildings in wood able to guarantee comfort and change the concept of living, putting environmental and

social sustainability in the first place. The wood the company uses is sourced from sustainably managed forests.

#### **4. Results and discussion**

The company has done much in its own factory to reduce CO<sub>2</sub> emissions. As regards investments targeted at the introduction of eco- innovations for processes and products for the containment of environmental pressures, for the reduction in the consumption of non-renewable resources of SMES (water and energy saving, reduction of emissions into the atmosphere and the production and hazards of waste, use of renewable energy sources, reuse of wastewater, the following measures have been put into action:

- a suitable tank has been prepared for the recovery of the rain water that will be re-used for irrigation and for the supply of storage tanks for the fire protection system (water saving)
- a photovoltaic plant has been installed with a power P=96,60kW<sub>p</sub>, for the electrical supply of the traditional factory (use of renewable energy sources and energy Saving and reduction of emissions into the atmosphere with a quantified forecast of the reduction of CO<sub>2</sub> emissions and of other greenhouse gases expressed in CO<sub>2</sub> equivalent)
- a semiautomatic plant has been installed, closed for the step of impregnation treatment of wooden, which envisages the use of water-based products with a low SOV content, that also allows the recovery of the process water avoiding the continuous disposal of it (reduction of production and hazards of waste)
- a plant for the recovery of wood powders has been installed which come from the cutting process of the wood that instead of being disposed of as waste will be sent in a plant for processing into briquettes fuels, the latter, however, is not yet present but is planned to be installed soon (reduction of production and hazards of waste).

The company has also joined a system of certified environmental management in accordance with UNI EN ISO 14001. As far as it concerns the use of techniques aimed at energy saving and/or production of renewable energy aimed at the reduction of CO<sub>2</sub> emissions are concerned, the interventions of energy efficiency in terms of annual saving of electricity envisaged in the ministerial decrees on July 20 2004, calculated according to the parameters emanated by the authority for the electric energy and the gas (AEEG) assuming: 2.5 tonn CO<sub>2</sub>/tep. Particularly the interventions made are concerning to several datasheet (illustrated below) for the quantification of the energy savings.

***First operation:***

- Installation of high-quality compact fluorescent energy-saving light bulbs.
- Installation of No 50 light bulbs with P = 15 W, F ≥ 874 lumen, for the indoor and outdoor lighting, with the results presented in Table 1.

**Table 1.** The equivalent overall CO<sub>2</sub> reduction as a result of installation of high-quality compact fluorescent energy-saving light bulbs

<i>No expected light bulbs</i>	<i>Specific Unit Net savings [10<sup>-3</sup> tep/year]</i>	<i>Total Net Specific savings [10<sup>-3</sup> tep/year]</i>	<i>Equivalent overall CO<sub>2</sub> reduction [10<sup>-3</sup> tons/year]</i>
50	4,712	235.6	<b>589</b>

***Intervention no. 2 – Data Sheet 07:***

- Installation of a photovoltaic plant of 96.6 kW<sub>p</sub> has as results the data illustrated in Table 2.

**Table 2.** The equivalent overall CO<sub>2</sub> reduction as a result of installation of a photovoltaic plant

<i>Peak power point kW<sub>p</sub></i>	<i>Solar range 5</i>	<i>Total Net savings [10<sup>-3</sup> tep/year]</i>	<i>Total equivalent reduction of CO<sub>2</sub> [10<sup>-3</sup> tons/year ]</i>
96,6	1852	33.454,79	<b>83.636,59</b>

**Intervention no. 3**

- Installation of high-efficiency external air-conditioner with cooling capacity of less than 12 kWf.

**Table 3.** The equivalent overall CO<sub>2</sub> reduction as a result of installation of a high-efficiency external air-conditioner

<i>Cooling capacity kW<sub>f</sub></i>	<i>Province group 3 [10<sup>-3</sup> tep/year/kW<sub>f</sub>]</i>	<i>Total net specific saving [10<sup>-3</sup> tep/year)</i>	<i>Overall equivalent of CO<sub>2</sub> reduction [10<sup>-3</sup> tons/year]</i>
12	3.8	45.6	<b>114</b>

The total annual reduction of CO<sub>2</sub> is thus equal to:

$$(589 + 83.636,59 + 114) \times 10^{-3} \text{ [tons CO}_2\text{/year]} = \mathbf{84.34 \text{ [tons CO}_2\text{/year]}}$$

**5. Conclusions**

Our analysis confirms the results from previous studies that for current conditions wood framed buildings will emit less CO<sub>2</sub> during their life cycle than concrete buildings. The choice of buildings materials influences the production energy, and the wood-framed building required less energy than the functionally identical concrete and steel framed building. Our results showed that wood-framed constructions use low energy.

This study suggests that a net reduction of CO<sub>2</sub> emission can be obtained by increasing the proportion of wood-based materials used in building construction, instead of other materials. Certainly, the company could do more to reduce CO<sub>2</sub> emissions in comparison to the buildings object of other studies, but it is not so far from the standards. An important topic for future is to understand the importance of the use of wood in buildings to minimize net CO<sub>2</sub> emission.

**6. References**

AIA, (1999), *Environmental Resource Guide*, American Institute of Architects, Wiley, New York.  
 Augenbroe G., Pearce A. R., Kibert C. J., (1998), Sustainable construction in the United States of America: A perspective to the year 2010, CIB-W82 Report, Georgia Institute of Technology, Atlanta, Ga, On line at: <http://infohouse.p2ric.org/ref/14/13358.htm>.  
 Börjesson P., Gustavsson L., (2000), Greenhouse gas balances in building construction: wood versus concrete from life-cycle and forest land-use perspectives, *Energy Policy*, **28**, 575-588.  
 Buchanan A.H., Honey B.G., (1994), Energy and carbon dioxide implications of building construction, *Energy and Buildings*, **20**, 205-217.  
 Canadian Wood Council, (1997), A case study: Comparing the environmental effects of building systems, Report No. 4, Canadian Wood Council, Ottawa, Ontario, Canada.  
 Cole R.J., (1999), Energy and greenhouse gas emission associated with the construction of alternative structural systems, *Buildings and Environment*, **34**, 335-348.  
 Fossdal S., (1995), Energy and environmental accounts of building construction (in Norwegian), Report 173, The Norwegian Institute of Building Research, Oslo, Norway.

- González M.J., Garcia Navarro J., (2006), Assessment of the decrease of CO<sub>2</sub> emissions in the construction field through the selection of materials: Practical case study of three houses of low environmental impact, *Building and Environment*, **8**, 902-909.
- IPCC (1996), Revised 1996 IPCC guidelines for National Greenhouse Gas Inventories, Volume 3: Reference Manual, Intergovernmental Panel on Climate Change, On line at: <http://www.ipcc-nggip.iges.or.jp/public/gl/invs6b.htm>.
- Lippke B., Wilson J., Perez-Garcia J, Bowyer J., Meil J., (2004). CORRIM: LifeCycle Environmental Performance of Renewable Building Materials, *Forest Products Journal*, **54**, 8-19.
- Spence R., Mulligan H., (1995), Sustainable Development and the Construction Industry, *Habitat International*, **19**, 279-292.
- USEPA, (2016), Green Building, On line at: <https://archive.epa.gov/greenbuilding/web/html/about.html>.
- Worrell E., van Heijningen R.J.J., de Castro J.F.M., Hazewinkel J.H.O., de Beer J.G., Faau A.P.C., Vringer K., (1994), New gross energy requirement figures for material production, *Energy*, **19**, 627-640.





## Instructions for authors

### 1. Introduction

*Procedia Environmental Science, Engineering and Management* publishes paper selected from Conference Proceedings focusing on multi-disciplinary nature of the environmental issues, and offers authors and conference organizers a rapid way to make available maximum visibility for their papers. The main responsibility for paper selection and first peer-review belongs to the Conference Organizers, who should guarantee quality control, the review process and the content of individual conference papers.

Submission of a manuscript implies that the work described has not been published before (except in the form of an abstract or as part of a published lecture, review, or thesis); that it is not under consideration for publication elsewhere; that its publication has been approved by all coauthors, if any, as well. The Conference Organizers and the Editor-in-Chief will agree and sign a bilateral agreement with technical and financial details for paper publication.

Papers, books for review, offers to review, suggestions and commercials (advertising) should be submitted to the Editor-in-Chief or Co-Editor. All papers will be published in English. Non-English speaking authors should seek the advice of a professional language expert or an English speaker to help translate the paper.

### 2. Legal requirements

The Conference Organizers and author(s) guarantee that the manuscript is/will not be published elsewhere in any language without the consent of the copyright holders, that the rights of third parties will not be violated, and that the publisher will not be held legally responsible should there be any claims for compensation.

Authors wishing to include figures or text passages that have already been published elsewhere are required to obtain permission from the copyright holder(s) and to include evidence that such permission has been granted when submitting their papers. Any material received without such evidence will be assumed to originate from the authors. The author(s) are encouraged to transfer the copyright of the article to the publisher upon acceptance of an article by the journal, using the *Authors' Warranty and Assignment of Copyright agreement*. This transfer enables the Editor to protect the copyrighted material for the authors, but does not resign the authors' proprietary rights. The publication of an article is conditioned by the signature of the author to whom correspondence should be addressed on this *Authors' Warranty and Assignment of Copyright agreement* that is provided by the Editor.

#### *Ethics in publishing*

For information on ethics in publishing for journal publication please read the [Journal Ethics](#).

#### *Conflict of interest*

All authors are requested to disclose any actual or potential conflict of interest such as any financial, personal or other relationships with other people or organizations concerning the submitted work that could inappropriately influence, or be perceived to influence, their work.



### 3. Editorial procedure

Maximum 10 pages are accepted (including Abstract, Keywords, References, Figures and Tables), processed with MS editing facilities, using the [manuscript template](#).

Manuscripts should be written in US English and submitted electronically, in .doc format (please do not use .docx) by the Conference Organizers to the Editor-in-Chief, at [procedia\\_ensem at yahoo dot com](mailto:procedia_ensem@yahoo.com). Please be sure to include your full affiliation address and e-mail address.

### 4. Manuscript preparation

Authors must follow guide for authors strictly ([manuscript template](#)), failing which the manuscripts would be rejected without review. Editors reserve the right to adjust the style to certain standards of uniformity.

Manuscripts should be concise, in 1.5 line spacing, and should have 2 cm all over margins. The font should be Times New Roman of size 12 points. The numbering of chapters should be in decimal form. Ensure that each new paragraph is clearly indicated, using TAB at 1.25 pts.

#### ***Title page will contain***

A concise and informative title (Times New Roman bold, all caps of size 13points); the maximum length of the title should be maximum 150 letters and spaces; The full name(s) of the author(s) (first name, then last name, with Times New Roman bold 11 points) should be written below the title. The affiliation(s) and complete postal address (es) of the author(s) will be provided immediately after the full name of the authors and will be written with Times New Roman italic 9 points. When the paper has more than one author, their name will be followed by a mark (Arabic numeral) as superscript; for the corresponding author, two asterisks will be added using *Word\_Insert\_Reference\_Footnote\_Symbol* sequence.

Also, the full and e-mail addresses, telephone and fax numbers of the corresponding author will be provided in the footer of the first page, as: *Corresponding author*: email..., Only one corresponding author has to be provided.

**Abstract:** each manuscript must be preceded by an abstract presenting the most important results and conclusions in no more than 300 words, written with Times New Roman 9 points.

**Key words:** three to five key words should be supplied after the Abstract for indexing purposes, **ordered alphabetically**, using American spelling and avoiding general and plural terms and multiple concepts (avoid, for example, "and", "of"). Be sparing with abbreviations: only abbreviations firmly established in the field may be eligible. These keywords will be used for indexing purposes.

The text of the paper should be divided into Introduction, Experimental, Results and Discussion, Conclusions, References (or Case-studies presentation instead of experimental).

**The text layout must be on a single column.**

#### **Introduction**

State the objectives of the work and provide an adequate background, avoiding a detailed literature survey or a summary of the results.

#### **Material and methods**

Provide sufficient detail to allow the work to be reproduced. Methods already published should be indicated by a reference: only relevant modifications should be described.

#### **Experimental**

Provide sufficient detail to allow the work to be reproduced. Methods already published should be indicated by a reference: only relevant modifications should be described.

#### **Results and Discussion**

Results should be clear and concise. Discussion should explore the significance of the results of the work, not repeat them. Avoid extensive citations and discussion of published literature.

## Conclusions

The main conclusions drawn from results should be presented in a short Conclusions section (maximum 100 words).

**Formulae, symbols and abbreviations** Formulae will be typeset in Italics (preferable with the Equation Editor) and should be written or marked for such in the manuscript, unless they require a different styling. The formulae should be quoted on the right side, between brackets:

$$(x_1+x_2)^2 = x_1^2 + x_2^2 + 2x_1x_2 \quad (1)$$

Abbreviations should be defined when first mentioned in the abstract and again in the main body of the text and used consistently thereafter.

SI units must be used throughout.

Footnotes should be avoided.

**References** The list of References should only include works that are cited in the text and that have been published. References should be cited in the text in brackets (Harvard style) as in the following example: (Schmidt, 1989), (Schmidt and Walter, 1996), (Walter et al., 1999).

**References should be alphabetically listed at the end of paper, with complete details, as follows:**

### Books:

*Book chapter:* Names and initials of authors; year, article title; editors; title of the book (italic); edition; volume number; publisher; place; page number:

Cutaia L., Morabito R., Barberio G., Mancuso E., Brunori C., Spezzano P., Mione A., Mungiguerra C., Li Rosi O., Cappello F., (2014), *The Project for the Implementation of the Industrial Symbiosis Platform in Sicily: The Progress After the First Year of Operation*, In: *Pathways to Environmental Sustainability*, Salmone R., Saija G. (Eds), Springer Science & Business Media, Cham Heidelberg New York Dordrecht London, 205-214.

### Books:

Faber K., (2000), *Biotransformations in Organic Chemistry - A Textbook*, vol.VIII, 4th Edition, Springer, Berlin-Heidelberg-New York.

Handbook, (1951), *Handbook of Chemical Engineer*, vol. II, (in Romanian), Technical Press, Bucharest, Romania.

**Symposia volumes:** Names and initials of authors; year; article title; full title; symposium abbreviated; volume number; place; date; page number:

Masutti D.C., Borgognoni A., Scardovi F., Vaccari C., Setti L., (2014), *Production of Lignocellulosic Enzymes from Different Agro-Food Wastes by Solid State Fermentation*, Proc. of 5<sup>th</sup> International Conference on Engineering for Waste and Biomass Valorisation - Rio de Janeiro, September 6th-8th, Brazil.

**Journal papers:** Names and initials of authors; year (between brackets); full title of the paper; full name of the journal (italic); volume number (bold); first and last page numbers:

Setti L., Giuliani S., Spinozzi G., Pifferi P.G., (1999), Laccase-catalyzed oxidative coupling of 3-methyl 2-benzothiazolinone hydrazone and methoxyphenols, *Enzyme Microbial Technology*, **25**, 285-289.

**Patents:** Names and initials of authors; year; patent title; country; patent number:  
Grant P., (1989), Device for Elementary Analyses. USA Patent, No. 123456.

**Dissertations:** Names and initials of authors; year; title; specification (Ph. D. Diss.); institution; place:

Guikema J.W., (2004), *scanning hall probe microscopy of magnetic vortices in very underdoped yttrium-barium-copper-oxide*, PhD Thesis, Stanford University, Stanford, USA.

Star K., (2008), *Environmental risk assessment generated by natural hazards*, MSc Thesis, Institute of Hazard Research, Town, Country.

**Legal regulations and laws, organizations:** Abbreviated name; year (between round brackets); full name of the referred text; document type; author; URL address:

JRC European Commission, (2011), *Supporting Environmentally Sound Decisions for Construction and Demolition (C&D) Waste Management*, A practical guide to Life Cycle Thinking (LCT) and Life Cycle Assessment (LCA), On line at: <http://lct.jrc.ec.europa.eu/pdf-directory/ReqNo-JRC65850-LB-NA-24916-EN-N.pdf>.

EC Directive, (2010), Directive 2010/75/EU of the European Parliament and of the Council of 24 November 2010 on industrial emissions (Integrated Pollution Prevention and Control), *Official Journal of the European Union*, **L334**, 17-119.

EC, (2014), Communication from the Commission to the European Parliament, the Council, the European Economic and Social Committee and the Committee of the Regions Towards a Circular Economy: A zero waste programme for Europe, European Commission, On line at: <http://ec.europa.eu/environment/circular-economy/>

Law 152 (2006), Legislative Decree No. 152 of the 03 April 2006, Environmental Regulations, *Official Journal*, No. 88 of the 14 April 2006 – Ordinary Supplement No. 96.

GD, (2004), Governmental Decision no. 1076/2004 surnamed SEA Governmental Decision, regarding the procedure for strategic environmental impact assessment for plans or programs, published in Romanian Official Monitor, part I, no. 707 from 5th of August, 2004.

**Web references:** The full URL should be given in text as a citation, if no other data are known. If the authors, year, title of the documents are known and the reference is taken from a website, the URL address has to be mentioned after these data.

Web references must not be listed separately, after the reference list.

**All references must be provided in English with a specification of original language in round brackets.**

Lorint C., (2012), *Natural Protected Areas and Biodiversity Preservation* (in Romanian), Universitas Press, Petroșani, Romania.

**Citation in text** Please ensure that every reference cited in the text is also present in the reference list (and vice versa). Do **not cite references in Abstract and Conclusions**

Unpublished results, personal communications as well as URL addresses are not recommended in the reference list, but may be mentioned in the text.

Citation of a reference as "in press" implies that the item has been accepted for publication. Papers which have been accepted for publication should be included in the list of references with the name of the journal and the specification "in press".

### **Abbreviations**

Define all abbreviations at their first mention in the text. Ensure consistency of abbreviations throughout the article.

### ***Acknowledgements***

Include acknowledgements in a separate section at the end of the article before the references and do not, therefore, include them on the title page, as a footnote to the title or otherwise. List here those individuals who provided help during the research (e.g., providing language help, writing assistance or proof reading the article, funding supports etc.).

### ***Footnotes***

Footnotes must be avoided. Do not include footnotes in the Reference list.

### ***Table footnotes***

Indicate each footnote in a table with a superscript lowercase letter.

### ***Tables***

Draw the tables in grid format using a basic, solid line style without shadows. Ensure that the data presented in Tables do not duplicate results described in Figures or elsewhere in the article.

### ***Figures***

Number Figures consecutively in accordance with their appearance in the text. All illustrations should be provided in camera-ready form, suitable for reproduction, which may include reduction without retouching.

Photographs, charts and diagrams are all to be referred to as Figure(s) and should be numbered consecutively, in the order to which they are referred.

Figures may be inserted as black line drawings. They should be pasted on, rather than taped, since the latter results in unclear edges upon reproduction.

Ensure that each illustration has a caption, placed below the Figure. A caption should comprise a brief title (not on the Figure itself) and a description of the illustration. Keep text in the illustrations themselves to a minimum but explain all symbols and abbreviations used. Multiple Figures can be expressed as one Figure (for e.g. 1a, 1b, 1c etc...), while retaining the maximum limit of 6.

**ALL Figures must be submitted in either .jpg or .tiff format with a very good resolution (but do not submit graphics that are disproportionately large for the content).**

**Figures and Tables must be embedded in the text.**

### ***Proofs***

Proofs will be sent to the corresponding author (mainly by e-mail) and should be returned within 48 hours of receipt. Corrections should be restricted to typesetting errors; any other changes may be charged to the author.

### ***Article in electronic format***

Authors are asked to submit their final and accepted manuscript as an attachment as .doc or .rtf document to the e-mail.

Authors are provided with the electronic format of the article as .pdf, free of charge. Further supplies in hard copy may be ordered on a reprint order form, which will be sent to the author from the Editor's office. This request will be formulated when the final form of the manuscript (the electronic one) is provided by the author.





Edited by the ***National Society of Environmental Science and Engineering*** (SNSIM) as Publisher  
(<http://snsim.ro/>)  
within the SNSIM Publishing House, Cluj-Napoca,  
Romania

